

Indice Generale

▶ L'Azienda

▶ Linea Style

▶ Linea Classica

▶ Linea Exit

▶ Accessori

▶ Note Tecniche

**ROYAL
PAT**



Aluform[®]

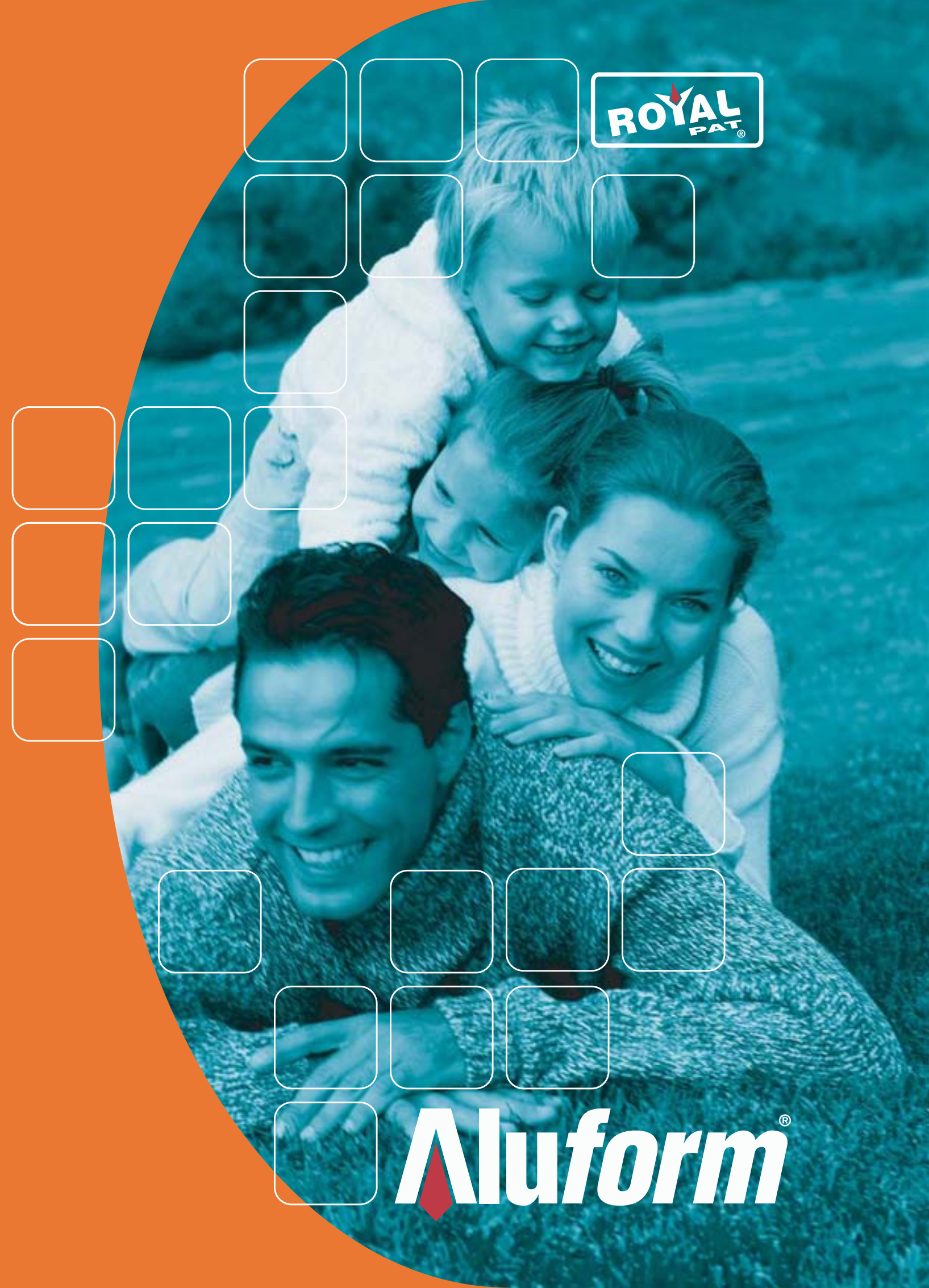

il marchio e l'azienda
the trademark and the profile of the company

Aluform®

Il marchio **Aluform®** è da sempre sinonimo di prodotti di alta qualità, che si è conquistato un ruolo di prestigio nel mercato delle porte d'ingresso.

L'universo che ci circonda costituisce la nostra principale fonte d'ispirazione per lo sviluppo di nuove proposte secondo un moderno concetto di casa.

Esplorare nuove tendenze per progredire costantemente nel segno dell'innovazione e della qualità tangibile, è la nostra filosofia.

The trademark Aluform® has always been synonymous of high quality products that has acquired a prestigious rule in the market of entrance doors.

The universe that surrounds us constitutes our main source of inspiration for the development of new proposals according to a modern concept of the house.

Exploring new trends to be constantly advancing in the world of innovation and tangible quality, this is our philosophy.



garanzia di originalità...
guarantee of originality...

Da sempre con il marchio Aluform firmiamo le migliori porte d'ingresso. In molti cercano di imitarci, ma la qualità e lo stile dei nostri prodotti sono caratteristiche inconfondibili ed inimitabili. Controllate sempre che la vostra porta sia corredata del nostro certificato di autenticità.



GARANZIA 10 ANNI
GUARANTEE YEARS

I pannelli ALUFORM in PIRALL®, sono garantiti per 10 anni da eventuali alterazioni causate da infiltrazioni d'acqua.

ALUFORM panels in PIRALL®, are guaranteed for 10 years against eventual alterations caused by water infiltration.

...e di qualità!
...and of quality!

Dopo la certificazione UNI EN ISO 9002 ottenuta già nel 2000, abbiamo raggiunto anche l'obiettivo della certificazione del Sistema di Gestione per la Qualità, in accordo alla nuova norma internazionale UNI EN ISO 9001:2000 (Vision 2000), per la capacità di fornire prodotti e servizi conformi alle aspettative dei nostri Clienti ed ai requisiti di legge applicabili. Nonostante questo significativo riconoscimento, il nostro maggiore motivo di orgoglio resta la fiducia dimostrataci quotidianamente dai nostri Clienti.

After the UNI EN ISO 9002 certification was obtained in 2000, we have also reached the objective of the System of Quality Management, in accordance with UNI EN ISO 9001:2000 (Vision 2000), the new international regulations, this enables us to supply products and services which conform to our Clients' expectations and the requests of the applied law. Other than this important recognition, our main reason to be proud is as always the trust placed in us daily by our Clients

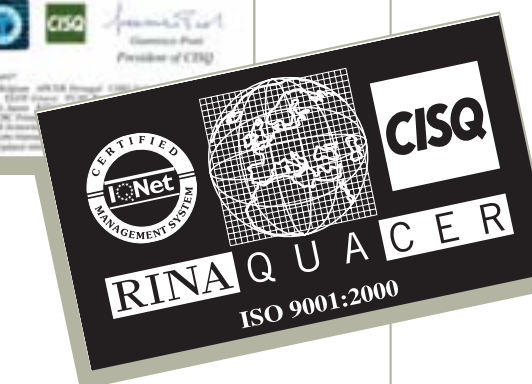

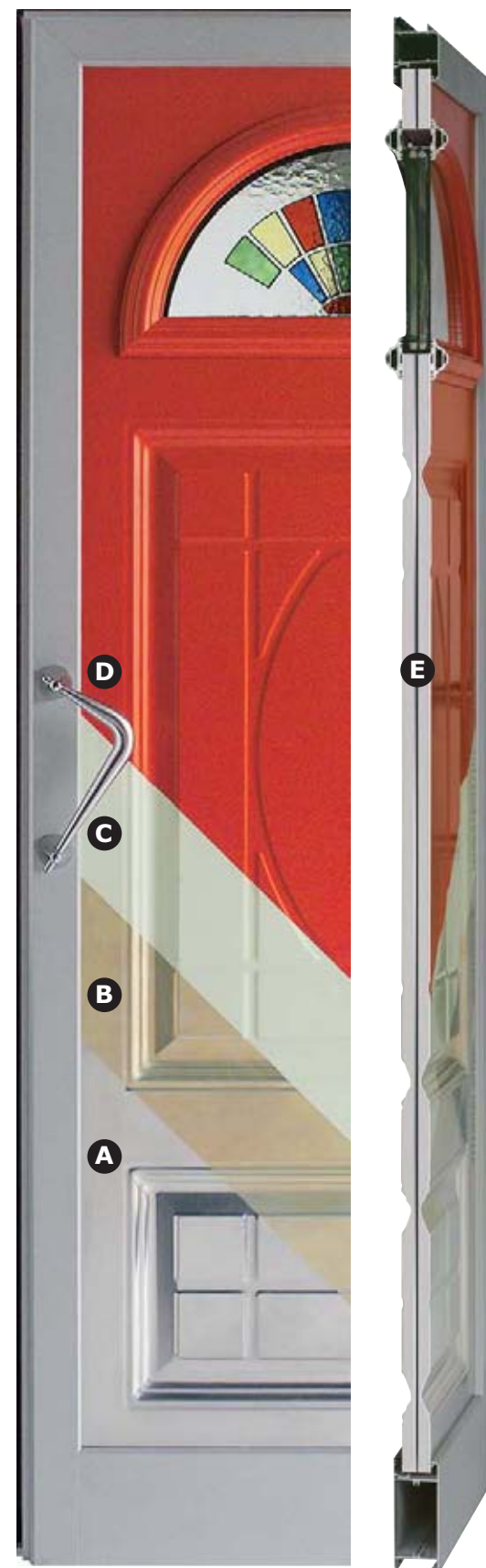

Per essere inattaccabili dal tempo e dagli agenti atmosferici, le lastre d'alluminio hanno bisogno di specifici trattamenti anticorrosivi sia all'esterno che all'interno, e cioè sulla superficie che resta a contatto con il nucleo centrale del pannello.

Il nostro sistema prevede:

- A) lastra in alluminio.**
- B) fosfocromatazione.**
- C) verniciatura protettiva al titanio.**
- D) verniciatura a polveri poliesteri.**
- E) nucleo centrale del pannello.**

Il tutto viene ripetuto in entrambi i lati delle due lastre in alluminio.

To make them immune from time and weather, the aluminium sheets need specific rustproofing treatments on both the outside and the inside – the surface that remains in contact with the central nucleus of the panel.

Our system includes:

- A) an aluminium sheet.**
- B) fosphochromatising.**
- C) titanium-based protective paintwork.**
- D) painting with polyester powders.**
- E) central nucleus of the panel.**

All this is repeated on both sides of the two aluminium sheets.

Un'infinita gamma di colori consente di personalizzare la Vostra porta secondo gli stili ed il contesto architettonico che la circonda.

Particolarmente interessanti sono le colorazioni effetto legno realizzate con pellicole Renolit, oppure i colori verniciato legno, che uniscono i vantaggi dell'alluminio al calore del legno.

Per i verniciati legno, dobbiamo però informarvi che, in questo genere di colori come per i colori anodizzati, per via delle speciali tecniche di verniciatura con cui vengono realizzati, non possiamo garantire l'uniformità della tonalità dei colori fra diversi lotti di produzione. Rientrano

pertanto nella normalità e non possono quindi essere oggetto di contestazione, differenti tonalità di colore fra pannello e telaio della porta e/o fra pannello e cornice del vetro.



An infinite range of colours allows us to customize your door to fit in with the styles and architectural context that surrounds it.

What are particularly interesting are the colouration possibilities in a wood effect, which are realised with Renolit pellicles, or the coloured woods, that unify the advantages of aluminium with the warmth of wood. However, we must inform you that for the wood colours as for the anodized colours, because of the special painting techniques they are produced in, we cannot guarantee a colour tone uniformity from one production lot to another.

However, different colour tonalities between panel and door frame and/or between panel and glass frame are in the normality and therefore cannot be an object of complaint.



Cartella colori Ral e Renolit



Tutti i modelli contrassegnati con il quadratino rosso sono brevettati.



Tutti i modelli contrassegnati con il quadratino rosso sono brevettati.



style



Avanti nel tempo con un design innovativo e raffinato.
Materiali classici come acciaio, alluminio e vetro, riscoperti ed abbinati fra loro con arte e ricercatezza per una porta d'ingresso intesa come moderno complemento d'arredo della vostra casa.
La forza di rivelare nuovi modi di essere per un prodotto che esprima sempre ed inequivocabilmente la Vostra esclusiva personalità.

Getting on in time with an innovating and refined design. Classical material like steel, aluminium and glass, found again and coupled with art and elegance for a front door, evolved like a modern furnishings complement for Your home. The strenght to reveal new way of being for a product that expresses, always and clearly, Your exclusive personality.

algenib



Mod. ALGENIB/XC1
Maniglia A 614
Vetro GS

Mod. ALGENIB/XC1
Maniglia A 685
Vetro GS
Grata inox GI

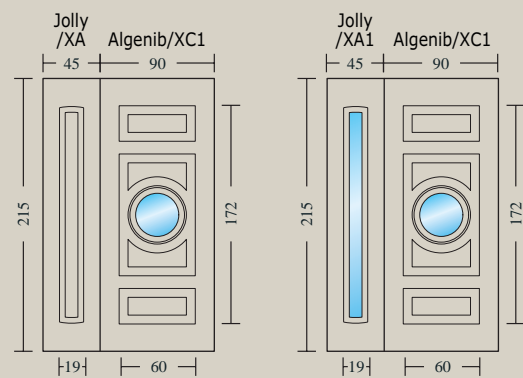

auriga



Mod. AURIGA/X1
Maniglia A 680
Vetro GS
Colore Renolit



Mod. AURIGA/X1
Maniglia A 614
Vetro GS
Grata inox GI
Colore Renolit

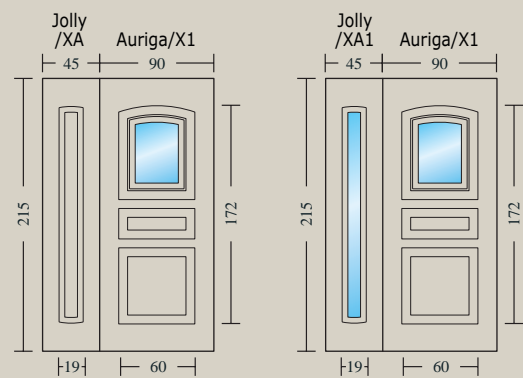

cassiopea

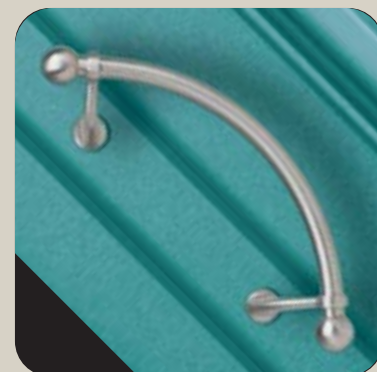

Mod. CASSIOPEA/X1
Maniglia A 618
Vetro GS

Mod. CASSIOPEA/X1
Maniglia A 680
Vetro GS
Grata inox GI

Mod. CASSIOPEA/X
Maniglia A 618

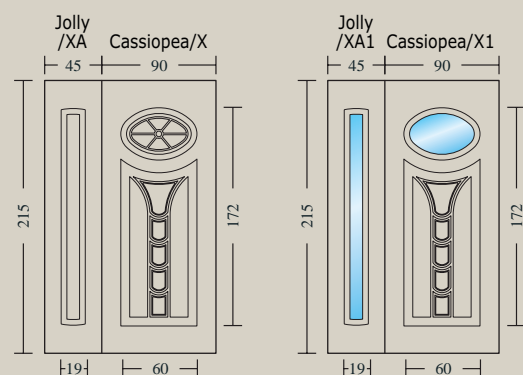

dream



Mod. DREAM/X3
 Maniglia integrata nel pannello
 Vetro GS

Mod. DREAM/X
 Maniglia integrata nel pannello

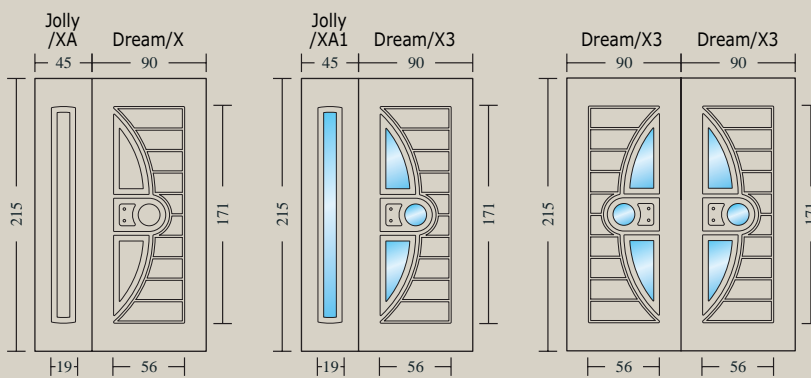

echo

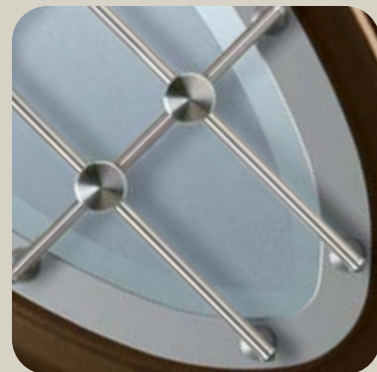

Mod. ECHO/X1
Maniglia A 618
Vetro GS



Mod. ECHO/X1
Maniglia A 670
Vetro GS
Grata inox GI

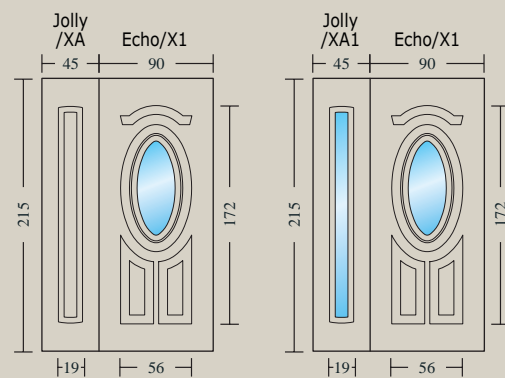

elisir



Mod. ELISIR/X1
Maniglia A 618
Vetro GS



Mod. ELISIR/X1
Maniglia A 614
Vetro GS
Grata inox GI

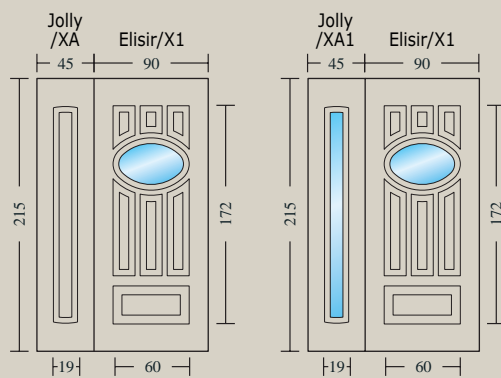

ellisse

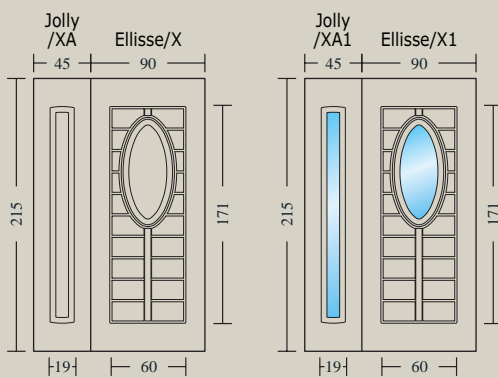

Mod. ELLISSE/X1
 Maniglia A 617
 Vetro GS
 Grata inox GI

Mod. ELLISSE/X
 Maniglia A 617

Mod. ELLISSE/X1
 Maniglia A 683 - Vetro GS

klio

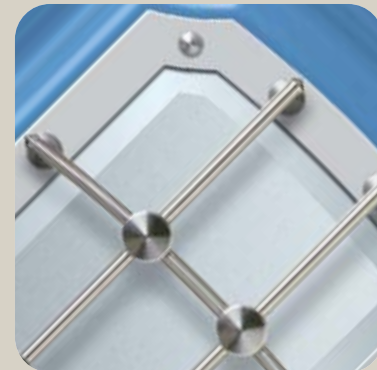
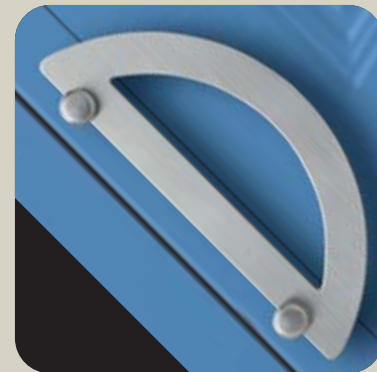

Mod. KLIO/X1
Maniglia A 681
Vetro GS

Mod. KLIO/X1
Maniglia A 617
Vetro GS
Grata inox GI

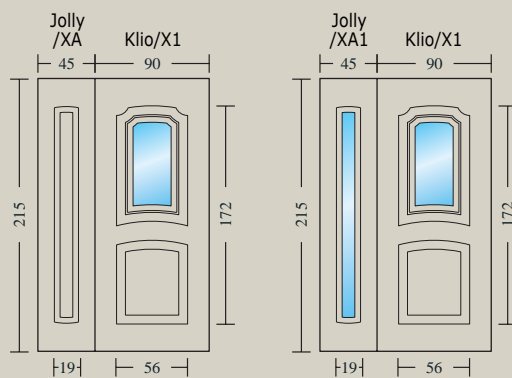

moon



Mod. MOON/X1
 Maniglia A 618
 Vetro GS
 Grata inox GI

Mod. MOON/X
 Maniglia A 680

Mod. MOON/X1
 Maniglia A 684 - Vetro GS

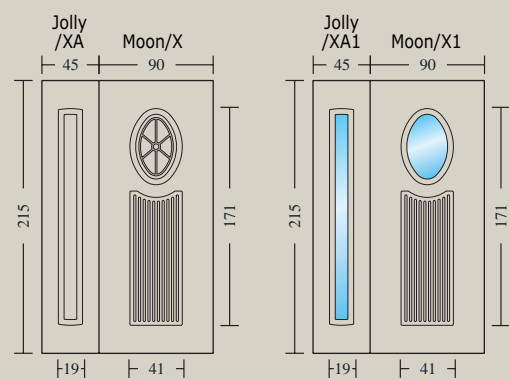

oblò

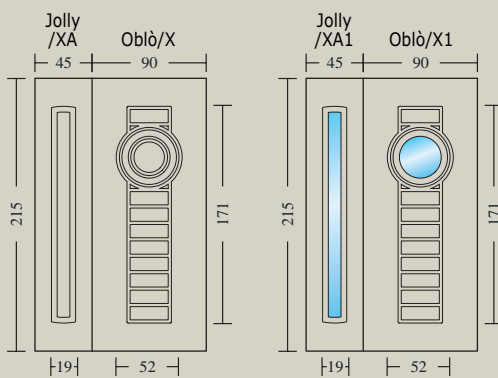

Mod. OBLÒ/X1
Maniglia A 503
Vetro GS
Grata inox GI

Mod. OBLÒ/X
Maniglia A 680

Mod. OBLÒ/X1
Maniglia A 685 - Vetro GS

onda

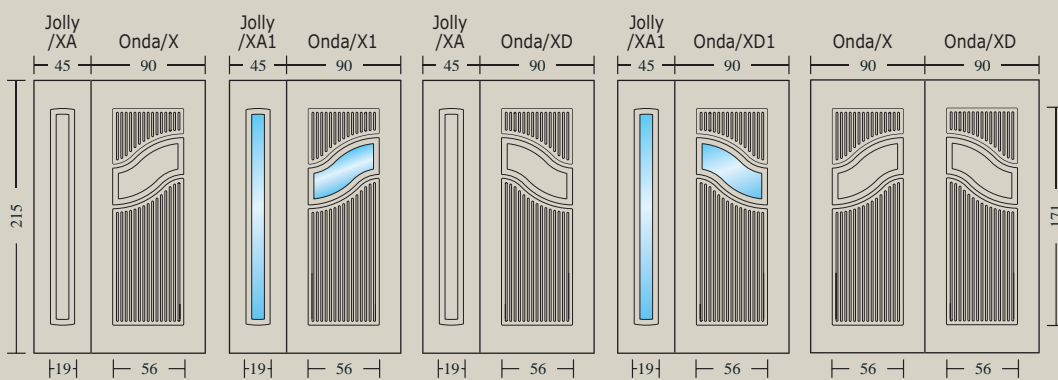

Mod. ONDA/XD
Maniglia A 680

Mod. ONDA/X1
Maniglia A 680
Vetro GS

Mod. ONDA/XD1
Maniglia A 680
Vetro GS

quadra

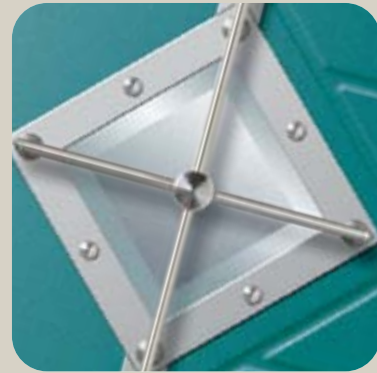

Mod. QUADRA/XD1
Maniglia A 690
Vetro GS

Mod. QUADRA/XD
Maniglia A 686

Mod. QUADRA/XD1
Man. A 682 - Vetro GS - Grata inox GI

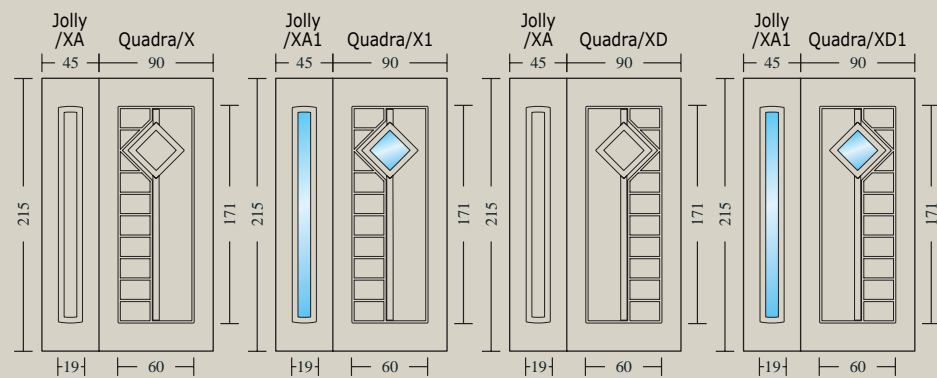

rotary



Mod. ROTARY/X
Maniglia A 680



Mod. ROTARY/X4
Maniglia A 680
Vetro GS

Mod. ROTARY/X4
Maniglia A 680
Vetro GS

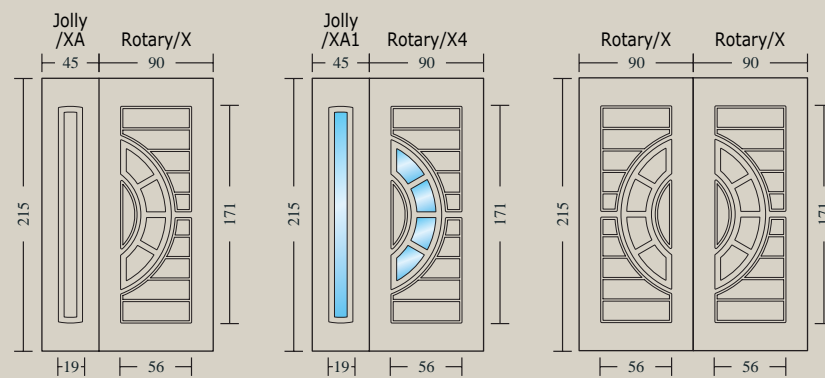

stilus

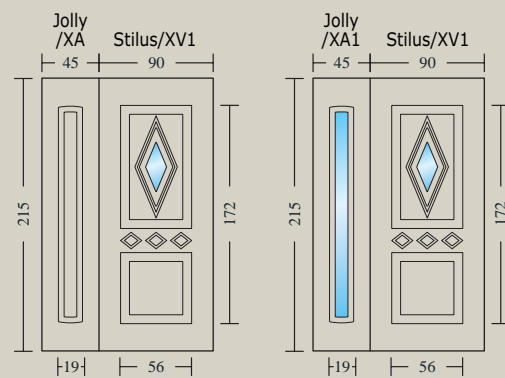

Mod. STILUS/XV1
Maniglia A 682
Vetro GS

Mod. STILUS/XV1
Maniglia A 616
Vetro GS
Grata inox GI

triangolo

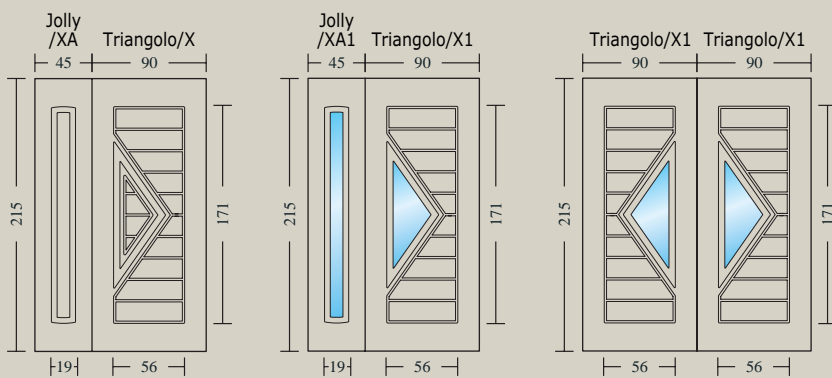

Mod. TRIANGOLO/X1
 Maniglia A 690
 Vetro GS
 Grata inox GI

Mod. TRIANGOLO/X
 Maniglia A 680

Mod. TRIANGOLO/X1
 Maniglia A 682 - Vetro GS

vele



Mod. VELE/X
Maniglia integrata nel pannello



Mod. JOLLY/XA1
Vetro GS

Mod. VELE/X2
Maniglia integrata nel pannello
Vetro GS

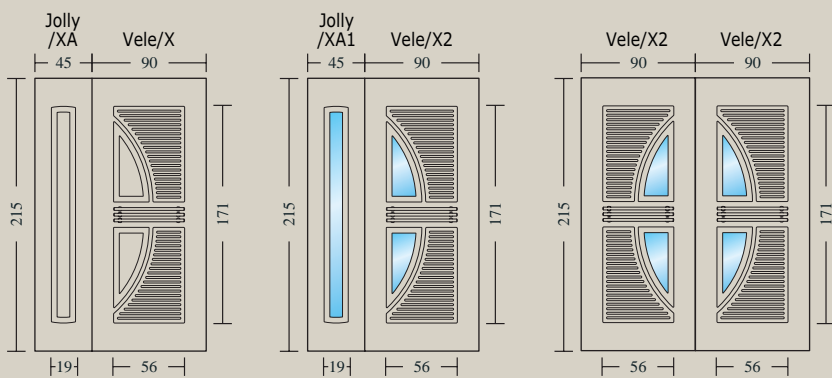

INDICE GENERALE

AVANTI

aluform



linea classica

Inedite linee classiche per una scelta legata alla tradizione delle forme, nel rispetto della nostra storia e dello stile architettonico che ci circonda, senza rinunciare alle attuali esigenze di sicurezza, isolamento ed assenza di manutenzione.

New classic lines for a choice gone with the tradition of making, in respect of our story and surrounding architectonic style, without renouncing the present safety, isolation and maintenance needs.



□ Mod. JOLLY/KG + ABACO/K
Maniglia A 406
Battente A 440



□ Mod. ABACO/K
Maniglia A 309
Battente A 320



Mod. ABACO / K - Maniglia A 309 - Battente A 320

abaco

abbinamenti

accessori

51

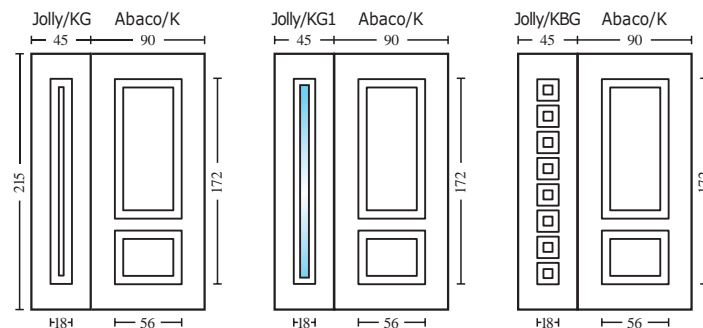

□ A 420



□ A 406



□ A 409



Collezione completa
accessori pag. 158-171



□ Mod. ALDEBARAN / K2
Maniglia A 470
Vetro GS
Grata inox GI

□ Mod. ALDEBARAN / K
Maniglia A 514

□ Mod. ALDEBARAN / KM
Maniglia A 514

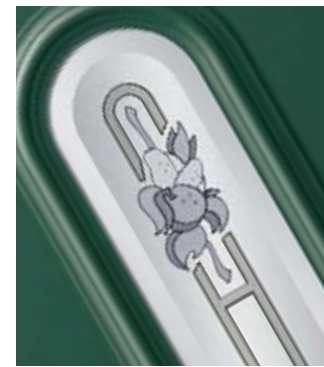

Vetro AN



Vetro GP



Vetro GN

Varianti e sezioni vetri
pag. 176-177



Mod. ALDEBARAN / KS1 + K2 - Maniglia A 470 - Vetro AC

aldebaran

abbinamenti

accessori

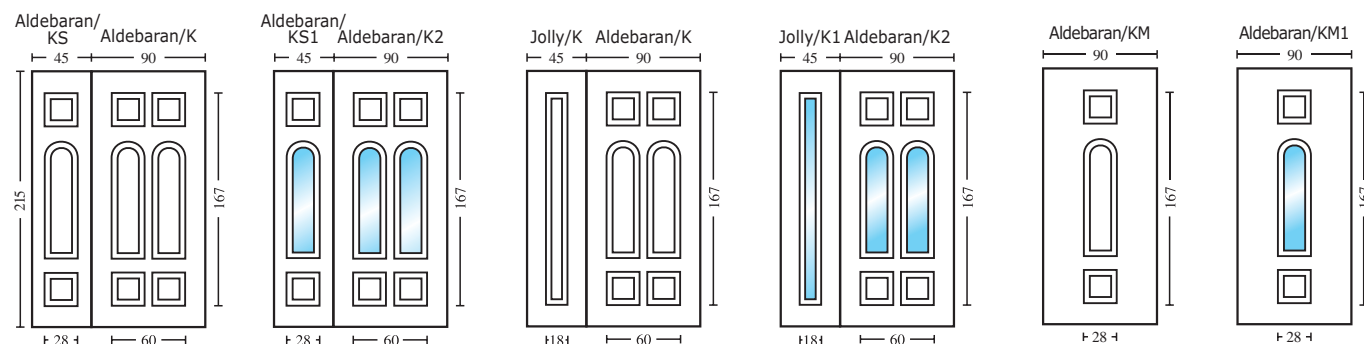

□ A 470

□ A 506

□ A 514

Collezione completa
accessori pag. 158-171





□ Mod. ALEX / K
Maniglia A 506

□ Mod. ALEX / K + ALEX/ KD
Maniglia A 680



Mod. ALEX / K - Maniglia 506

alex

abbinamenti

accessori

55

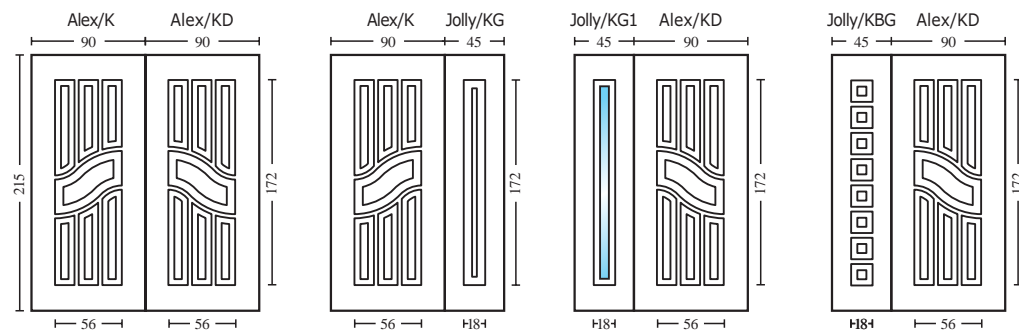

□ A 317

□ A 406

□ A 680

Collezione completa accessori pag. 158-171





□ Mod. ALFA / KM
Maniglia A 509

□ Mod. ALFA / K6
Maniglia A 417
Vetro AN

□ Mod. ALFA / K10
Maniglia A 409
Vetro GP

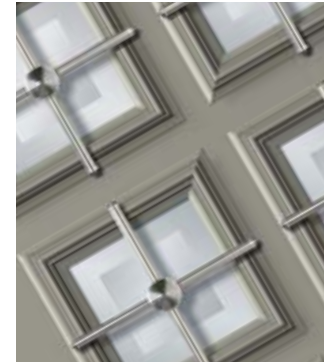

Vetro GS + Grata Inox GI



Vetro GN



Vetro AC

Varianti e sezioni vetri
pag. 176-177



Mod. ALFA / K - Maniglia 506

alfa

abbinamenti

accessori

57

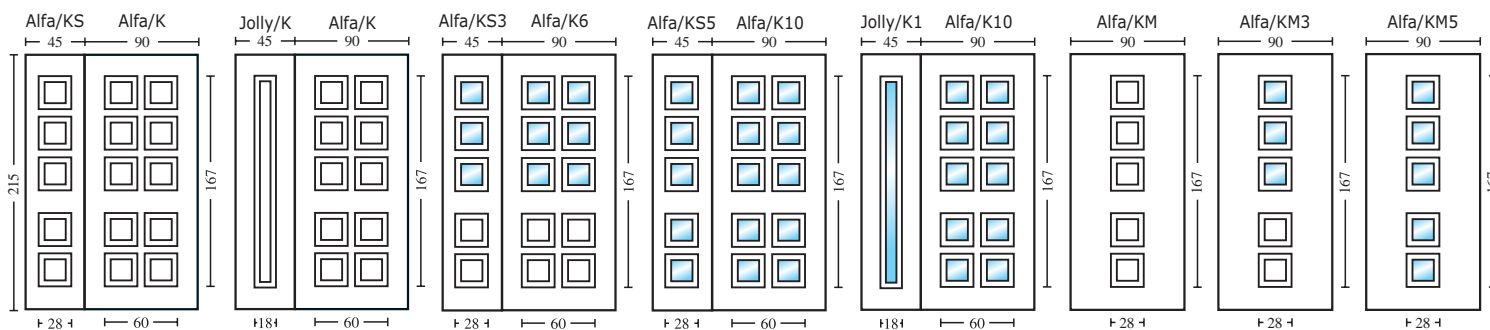

□ A 417

□ A 506

□ A 509

Collezione completa
accessori pag. 158-171





□ Mod. ALFAIR / KM1
Maniglia A 506
Vetro AC

□ Mod. ALFAIR / K
Maniglia A 517

□ Mod. ALFAIR / K2
Maniglia A 417
Vetro GP



Vetro GS + Grata Inox GI



Vetro AN



Vetro GN

Varianti e sezioni vetri
pag. 176-177

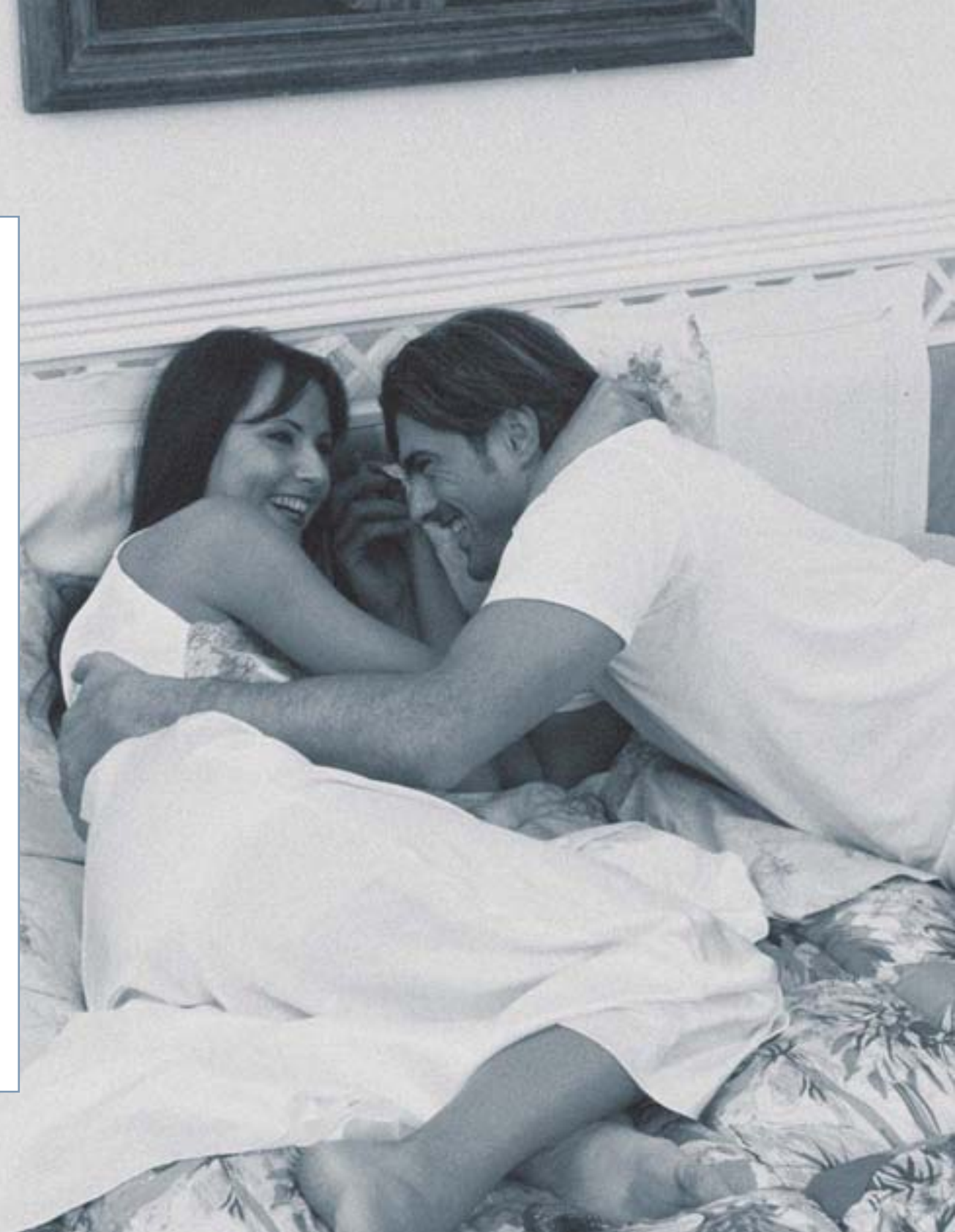

alfair

abbinamenti

accessori

59

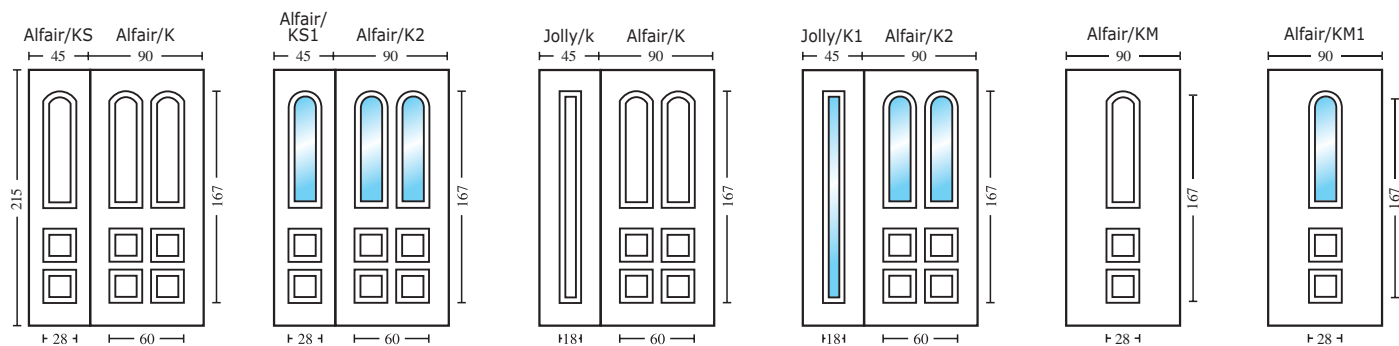

□ A 417

□ A 517

□ A 317

Collezione completa
accessori pag. 158-171





□ Mod. ALGENIB / KB
Maniglia A 515
Battente A 521
Colore Renolit

□ Mod. ALGENIB / KC
Maniglia A 560



Mod. ALGENIB / KB + ALGENIB / KC + ALGENIB / KB

algenib

abbinamenti

61

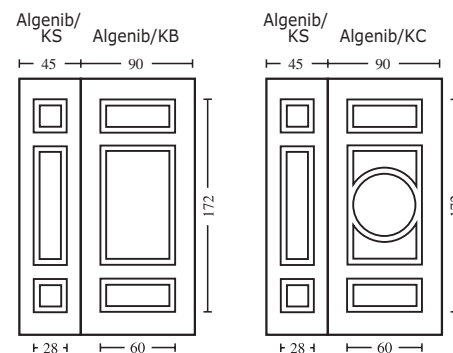

□ A 521



□ A 515



□ A 560



Collezione completa accessori pag. 158-171



□ Mod. ALGENIB / K
Maniglia A 414

□ Mod. ALGENIB / KD
Maniglia A 506

□ Mod. ALGENIB / KE
Maniglia A 506
Battente A 525



Vetro GS + Grata Inox GI

Vetro AC

Vetro AN

Vetro GN

Varianti e sezioni vetri
pag. 176-177



Mod. ALGENIB / KE1 - Maniglia A 682 - Vetro GP

algenib

abbinamenti

accessori

63

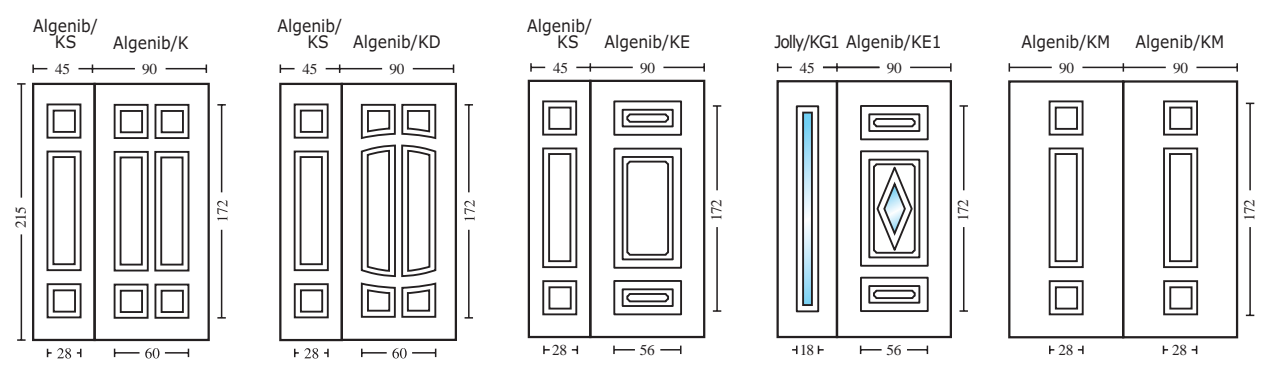

□ A 525



□ A 414



□ A 509



Collezione completa
accessori pag. 158-171

TORNA ALL'INDICE

INDIETRO

AVANTI



A 516



A 416



A 316

Collezione completa accessori a pag. 158



MOD. ALIZAR / K - Maniglia A 516

alazar

abbinamenti

65

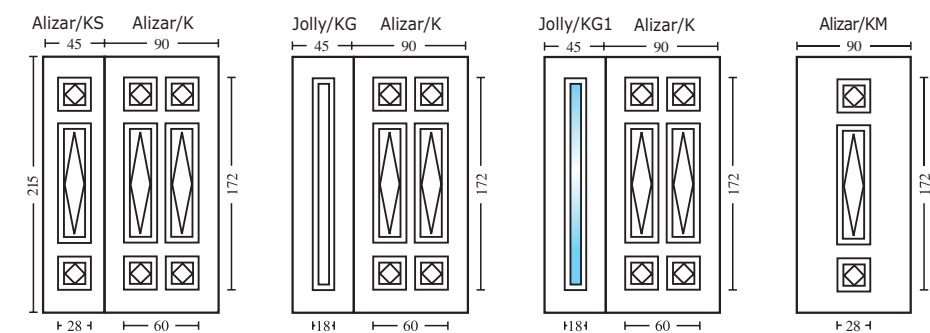



Mod. ANTARES / KD
Maniglia A 560
Battente A 520

Mod. ANTARES / KD1
Maniglia A 470
Vetro AC

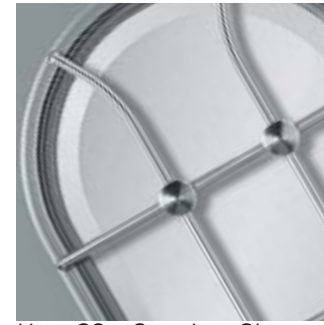

Vetro GS + Grata Inox GI

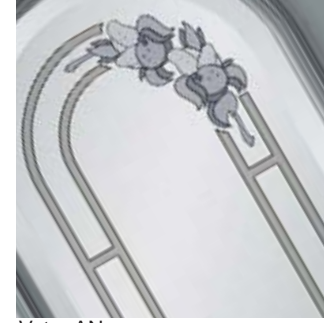

Vetro AN



Vetro GP

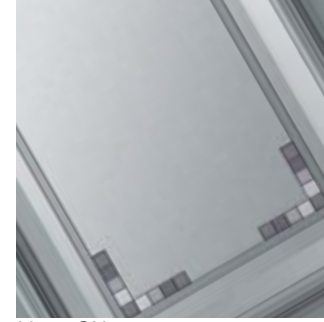

Vetro GN

Varianti e sezioni vetri
pag. 176-177

Mod. ANTARES / K - Maniglia A 417

antares

abbinamenti

accessori

67

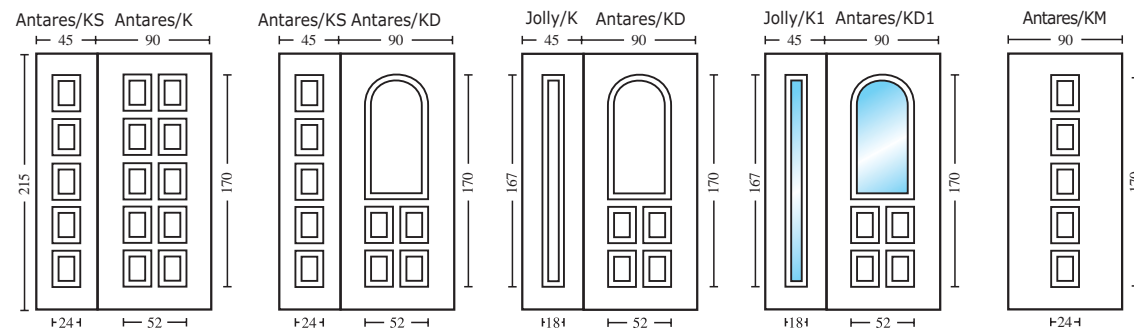

A 520



A 470



A 509



Collezione completa
accessori pag. 158-171



□ Mod. ARIES / KB + ARIES / KB
Maniglia A 517

□ Mod. ARIES / KS + Mod. ARIES / K + Mod. ARIES / KS
Maniglia A 409



Mod. ARIES / K - Maniglia A 409

aries

abbinamenti

accessori

69

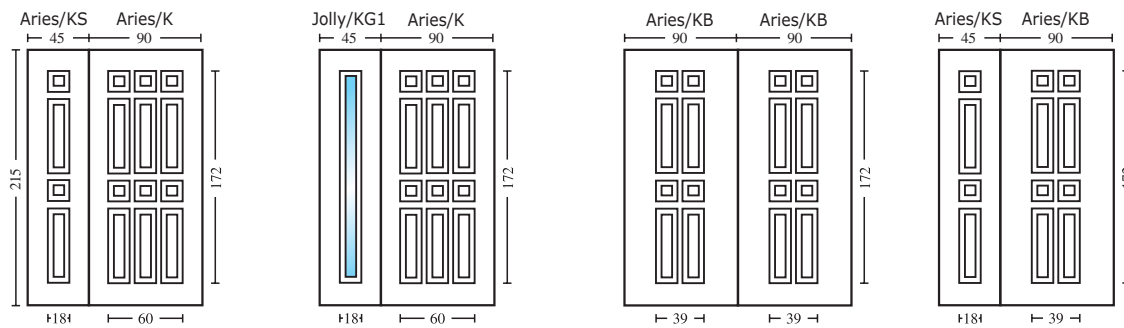

□ A 517

□ A 409

□ A 317

Collezione completa accessori pag. 158-171





□ Mod. ASTRA / K
Maniglia A 530

□ Mod. KLIO / KS + Mod. ASTRA / K
Maniglia A 509

Mod. ASTRA / K - Maniglia A 417

astra

abbinamenti

accessori

71

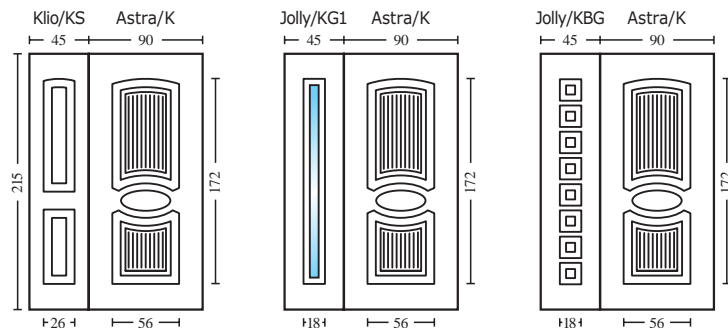

□ A 530



□ A 509



□ A 417



Collezione completa accessori pag. 158-171



□ Mod. AURIGA / KBS + Mod. AURIGA / KB
Maniglia A 309
Battente A 320
Colore Renolit

□ Mod. AURIGA / KB1
Maniglia A 509
Vetro AN

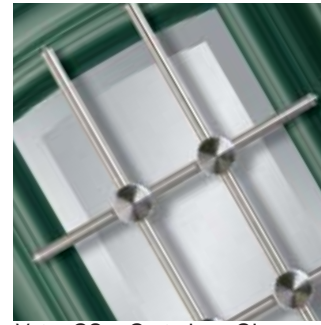

Vetro GS + Grata Inox GI



Vetro AC

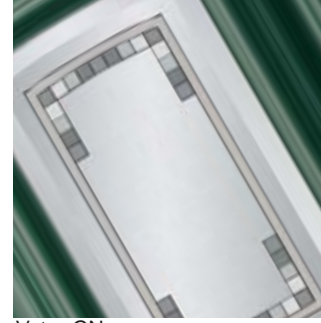

Vetro GN



Vetro GP

Varianti e sezioni vetri
pag. 176-177



Mod. AURIGA / K - Maniglia A 414 - Battente A 425

auriga

abbinamenti

accessori

73

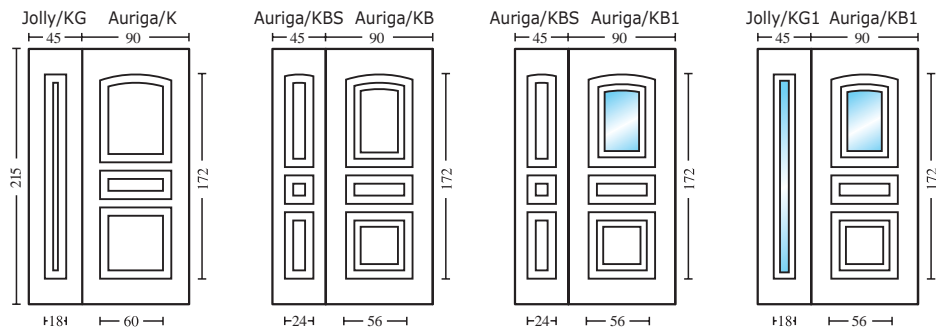

□ A 320



□ A 509



□ A 414



Collezione completa
accessori pag. 158-171



□ Mod. BASILEO / K
Maniglia A 560
Battente A 525

□ Mod. BASILEO / K1
Maniglia A 314
Vetro AC
Colore Renolit



Vetro GS + Grata Inox GI

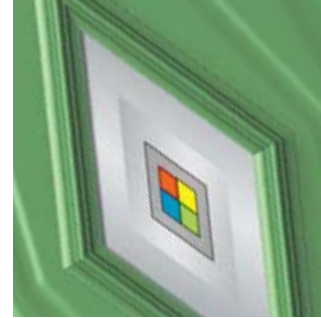

Vetro GP



Vetro AN

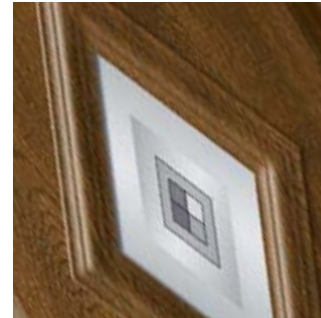

Vetro GN

Varianti e sezioni vetri
pag. 176-177

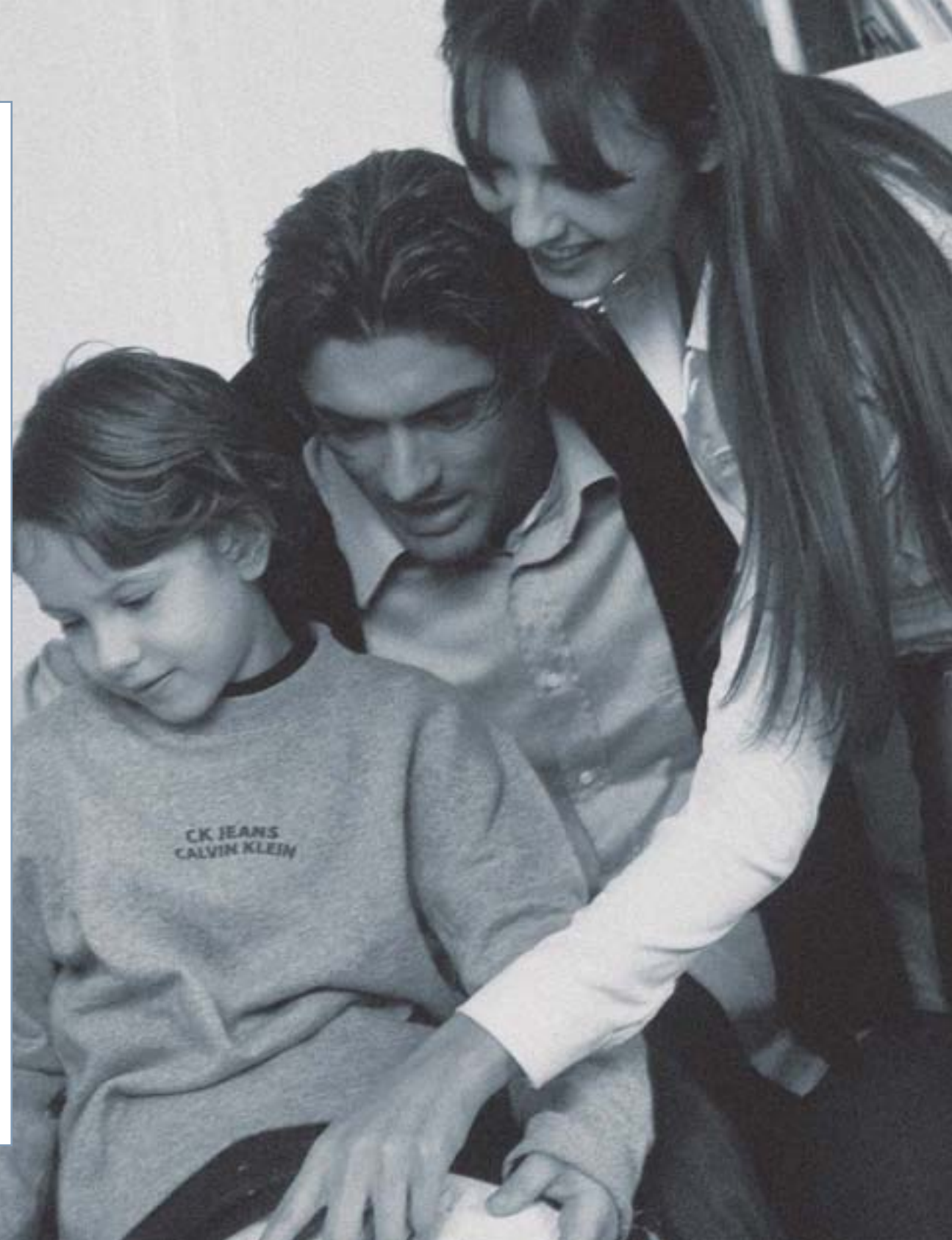

basileo

abbinamenti

accessori

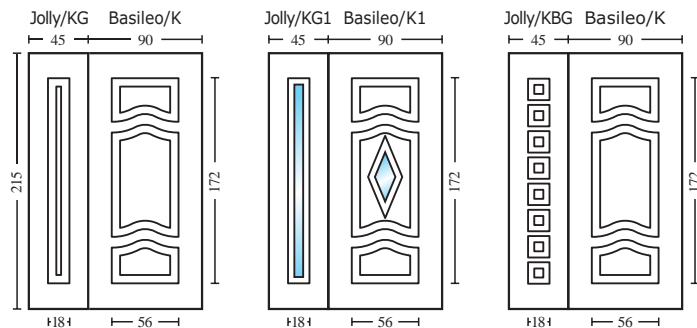

□ A 525



□ A 314



□ A 560



Collezione completa
accessori pag. 158-171



□ Mod. BELLATRIX / K1
Maniglia A 560
Vetro GP

□ Mod. BELLATRIX / K3
Maniglia A 416
Vetro GS
Grata Inox GI

□ Mod. BELLATRIX / K5
Maniglia A 470
Vetro AC



Vetro AN



Vetro GN

Varianti e sezioni vetri
pag. 176-177



Mod. BELLATRIX / K - Maniglia A 470 - Colore Renolit

bellatrix

abbinamenti

accessori

77

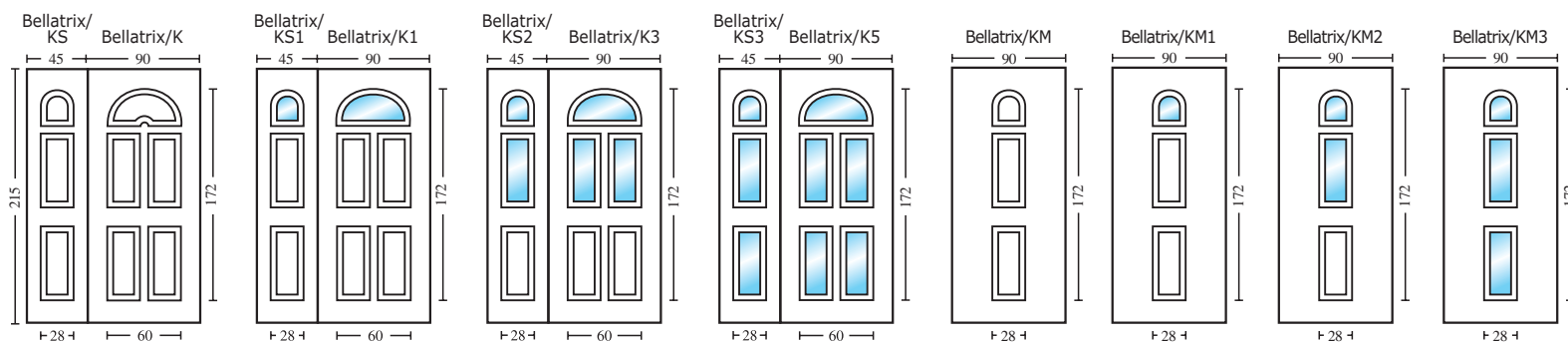

□ A 416

□ A 470

□ A 560

Collezione completa
accessori pag. 158-171



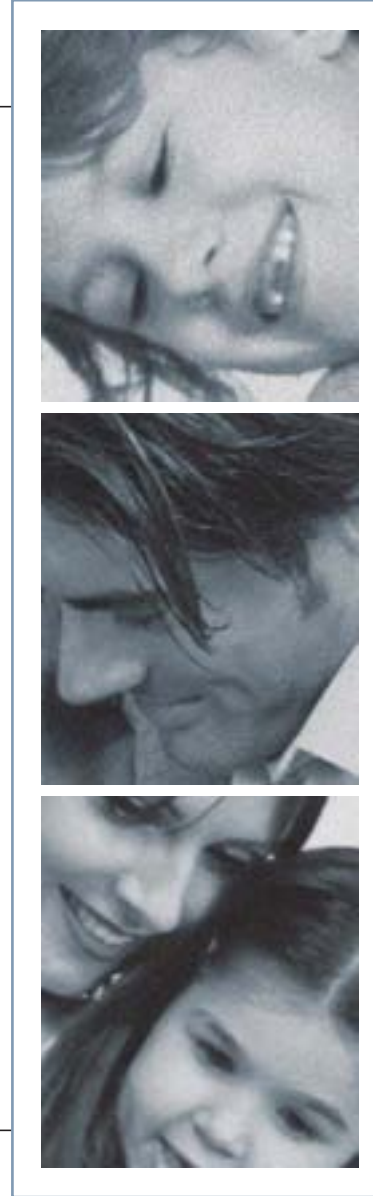

□ Mod. CASSIOPEA / K
Maniglia A 460
Colore Renolit

□ Mod. JOLLY / KBG + Mod. CASSIOPEA / K
Maniglia A 680

Mod. CASSIOPEA / K - Maniglia A 560

cassiopea

abbinamenti

accessori

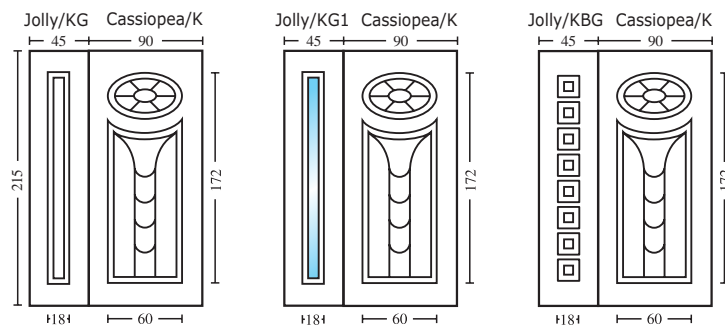

□ A 680

□ A 460





□ Mod. CASTORE / K1
Maniglia A 416
Vetro AC

□ Mod. CASTORE / K
Maniglia A 516

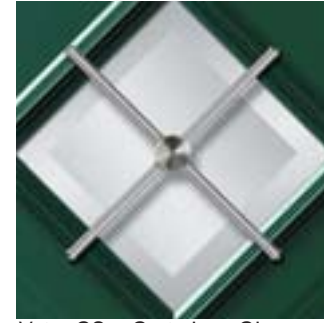

Vetro GS + Grata Inox GI



Vetro AN

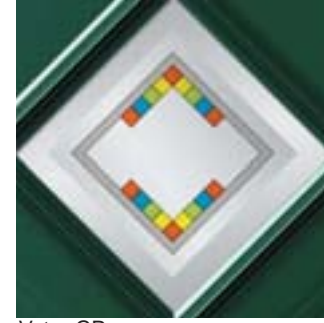

Vetro GP

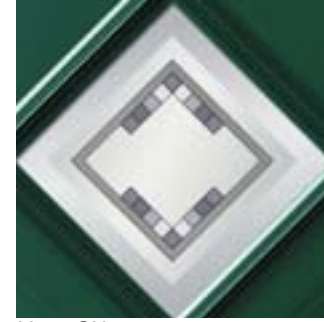

Vetro GN

Varianti e sezioni vetri
pag. 176-177



castore

abbinamenti

accessori

81

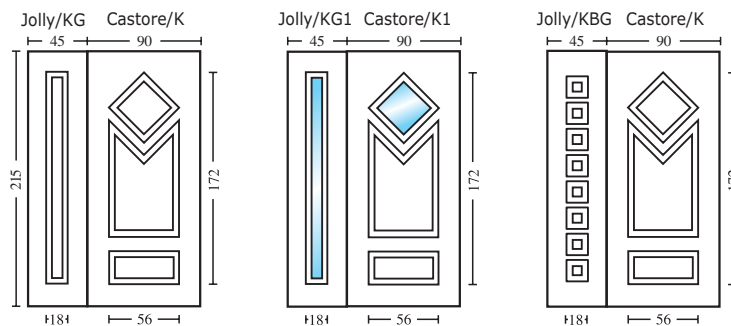

□ A 416

□ A 616

□ A 316

Collezione completa
accessori pag. 158-171





□ Mod. DORADO / K
Maniglia A 517

□ Mod. DORADO / K1
Maniglia A 417
Vetro GP

□ Mod. DORADO / KB1
Maniglia A 514
Vetro GS
Grata Inox GI



Vetro AN

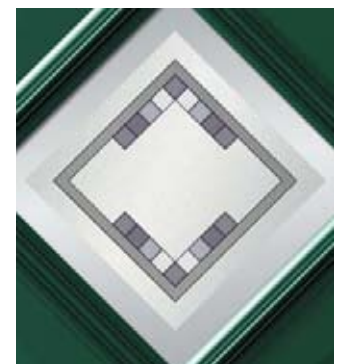

Vetro GN

Varianti e sezioni vetri
pag. 176-177



Mod. DORADO / KB1 - Maniglia A 517 - Vetro AC

dorado

abbinamenti

accessori

83

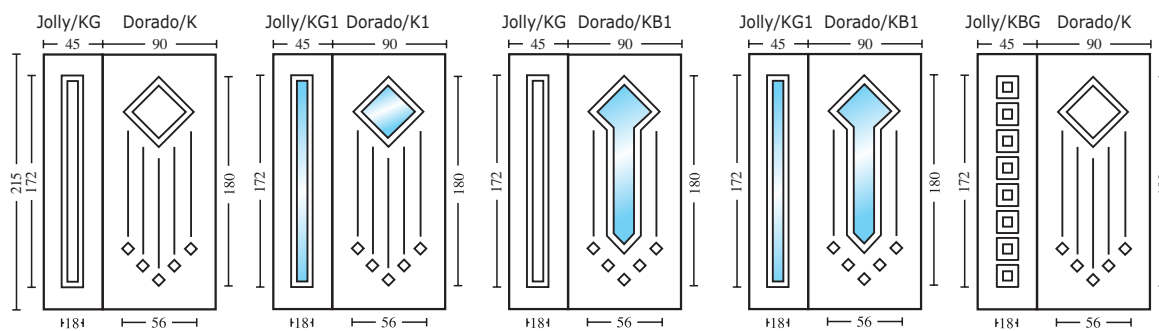

□ A 517

□ A 417

□ A 514

Collezione completa
accessori pag. 158-171





□ Mod. JOLLY / KBG + ECHO / K + JOLLY / KBG
Maniglia A 509
Battente A 540



Mod. ECHO / K - Maniglia A 560 - Battente A 540

echo

accessori

85

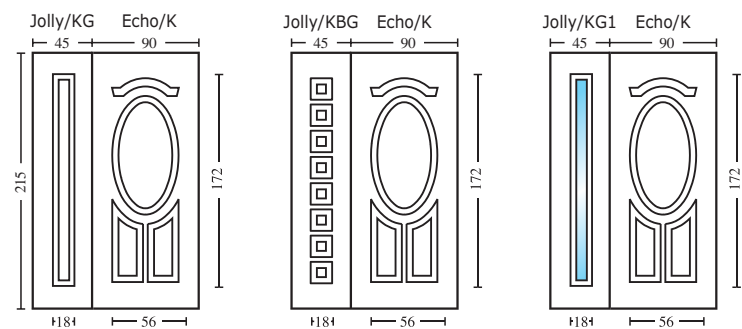

□ A 540



□ A 509



□ A 560

Collezione completa
accessori pag. 158-171



□ Mod. ELISIR / K
Maniglia A 506
Battente A 520

□ Mod. ELISIR / KB
Maniglia A 618



Mod. ELISIR / K - Maniglia A 417 - Battente A 420

elisir

abbinamenti

accessori

87

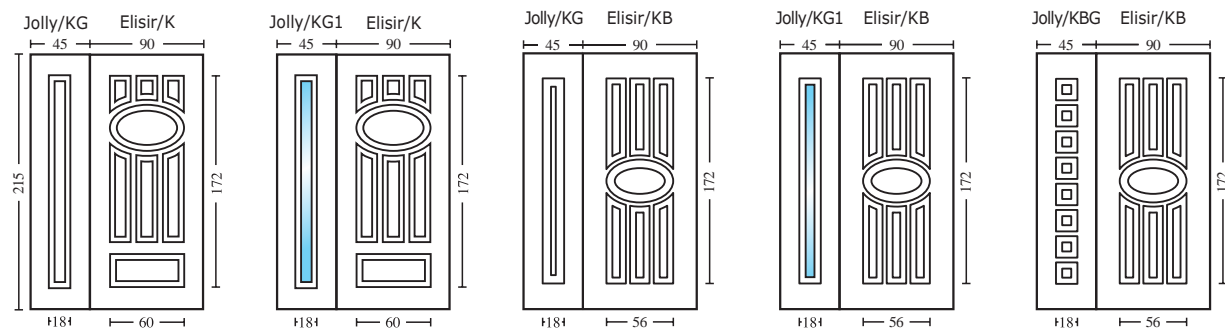

□ A 420



□ A 506



□ A 618



Collezione completa accessori pag. 158-171



□ Mod. ERIDANO / K6
Maniglia A 409
Vetro GS
Colore Renolit

□ Mod. ERIDANO / KS1 - Mod. ERIDANO / K2
Maniglia A 417
Vetro AC

□ Mod. ERIDANO / K
Maniglia A 414

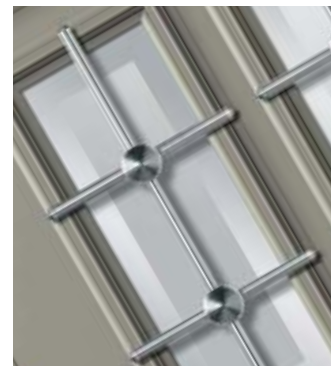

Vetro GS + Grata Inox GI



Vetro AN



Vetro GN

Varianti e sezioni vetri
pag. 176-177



Mod. ERIDANO / KS3 + ERIDANO / K6 - Maniglia A 517 - Vetro GP

eridano

abbinamenti

accessori

89

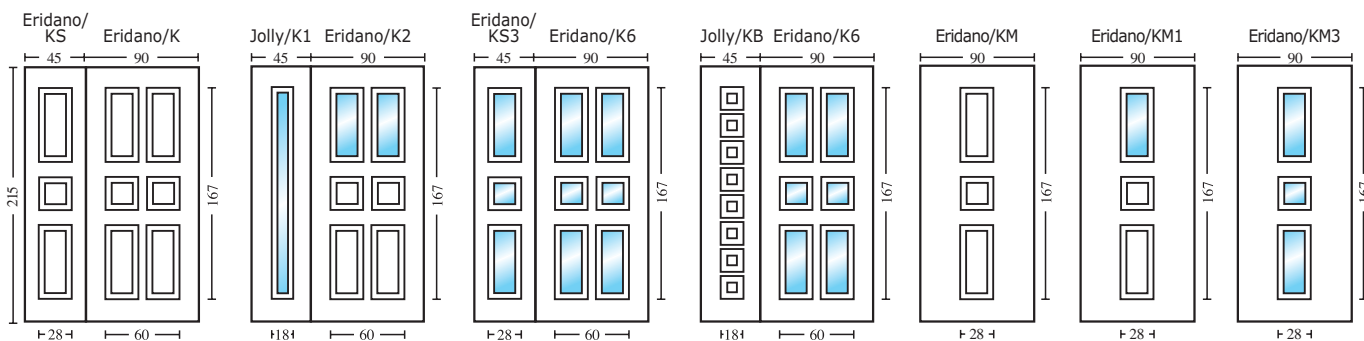

□ A 414

□ A 417

□ A 514

Collezione completa
accessori pag. 158-171





□ Mod. KLIO / KS - Mod. ERMES / K1
Maniglia A 430
Vetro AC

□ Mod. ERMES / K
Maniglia A 506
Battente A 520

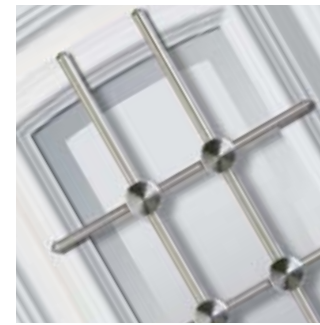

Vetro GS + grata inox GI



Vetro AN



Vetro GP



Vetro GN

Varianti e sezioni vetri
pag. 176-177

Mod. ERMES / K - Maniglia A 370 - Battente A 320



ermes

abbinamenti

accessori

91

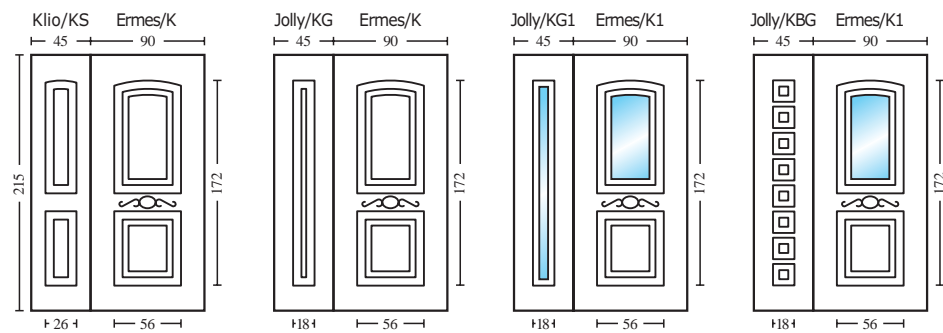

□ A 430



□ A 470



□ A 506



Collezione completa
accessori pag. 158-171



□ Mod. GEMINI / K1
Maniglia A 516
Vetro GS
Grata Inox GI

□ Mod. GEMINI / K1
Maniglia A 416
Vetro AC



Vetro AN



Vetro GP



Vetro GN

Varianti e sezioni vetri pag. 176-177



Mod. GEMINI / K - Maniglia A 516 - Battente A 520

gemini

abbinamenti

accessori

93

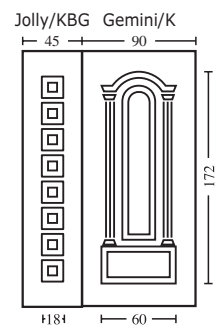
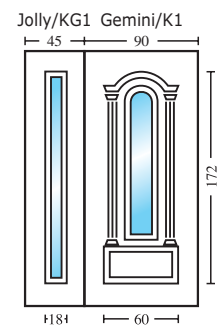
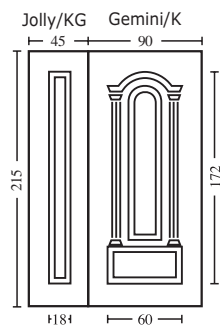

□ A 520



□ A 516



□ A 416



Collezione completa accessori pag. 158-171



□ Mod. GEMMA / K1
Maniglia A 470
Battente A 440
Vetro AC

□ Mod. GEMMA / K1
Maniglia A 570
Vetro GS
Grata Inox GI



Vetro AN

Vetro GP

Vetro GN

Varianti e sezioni vetri pag. 176-177



Mod. GEMMA / K - Maniglia A 470

gemma

abbinamenti

accessori

95

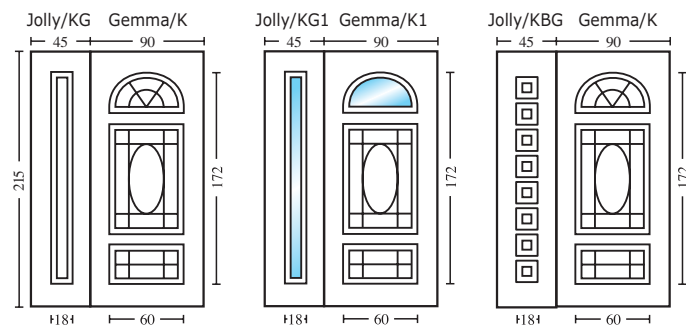

□ A 470

□ A 570

□ A 370

Collezione completa accessori pag. 158-171





Vetro AC



Vetro GN



Varianti e sezioni vetri pag. 176-177

Mod. GEO / K1
Maniglia A 409
Vetro AN
Colore Renolit

Mod. GEO / K1
Maniglia A 516
Vetro GS
Grata Inox GI

Mod. GEO / K1
Maniglia A 416
Vetro GP

Mod. GEO / K - Maniglia A 416 - Battente A 440

geo

abbinamenti

accessori

97

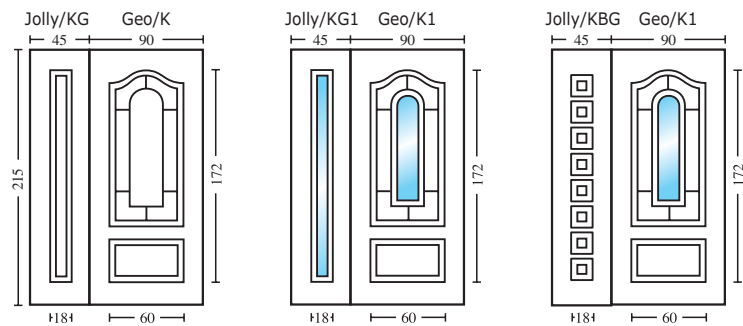

A 440



A 509



A 416



Collezione completa accessori pag. 158-171



□ Mod. IKARO / KB1
Maniglia A 414
Vetro GP

□ Mod. JOLLY / KG + MOD. IKARO / K1 + MOD. JOLLY / KG
Maniglia A 414
Vetro AC

□ Mod. IKARO / KC
Maniglia A 517

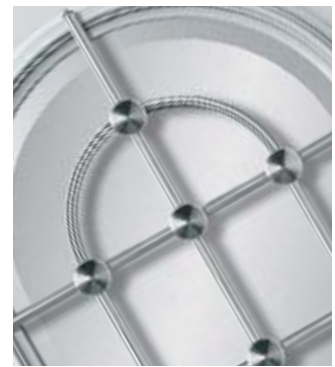

Vetro GS + Grata Inox GI



Vetro AN

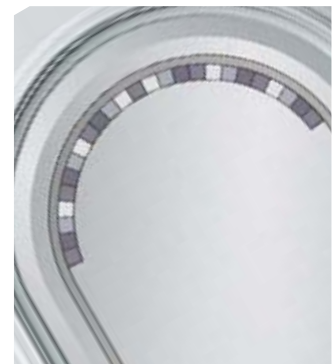

Vetro GN

Varianti e sezioni vetri
pag. 176-177



Mod. IKARO / K - Maniglia A 414

ikaro

abbinamenti

accessori

99

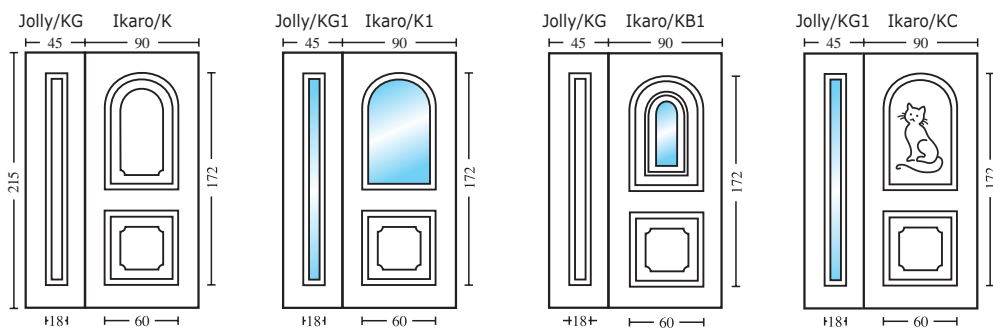

□ A 414

□ A 517

□ A 317

Collezione completa
accessori pag. 158-171





□ Mod. IRIS / K1
Maniglia A 515
Vetro GS
Grata inox GI

□ Mod. IRIS / KC1
Maniglia A 417
Vetro AC

□ Mod. IRIS / K3
Maniglia A 409
Vetro GP



Vetro AN

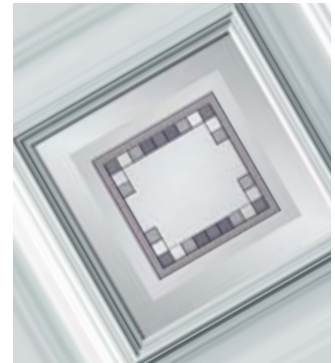

Vetro GN



Varianti e sezioni vetri
pag. 176-177



Mod. IRIS / K - Maniglia A 517

iris

abbinamenti

accessori

101

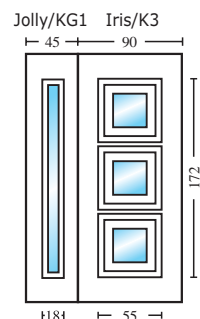
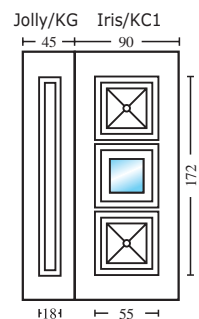
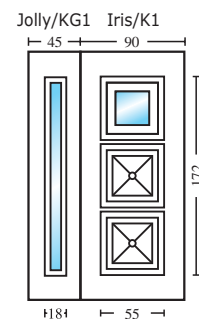
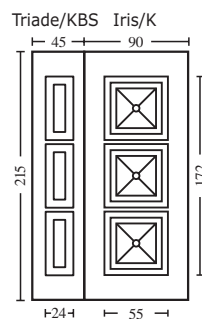

□ A 417

□ A 517

□ A 515

Collezione completa
accessori pag. 158-171





□ Mod. KALIPSO / KD
Maniglia A 514
Battente A 525

□ Mod. KALIPSO / K + KALIPSO / KS
Maniglia A 570
Battente A 540

Mod. KALIPSO / KB + KALIPSO / KC - Maniglia A 509

kalipso

abbinamenti

accessori

103

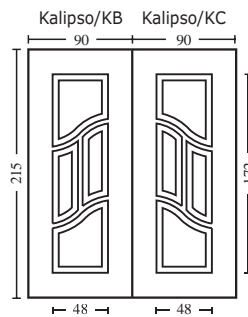

□ A 525



□ A 570



□ A 509



Collezione completa accessori pag. 158-171



□ Mod. KLIO / KB
Maniglia A 570
Battente A 540

□ Mod. KLIO / KD
Maniglia A 417
Battente A 420



Mod. KLIO / K + KLIO / KB + KLIO / KD

Mod. KLIO / KB - Maniglia A 570 - Battente A 525

klio

abbinamenti

105

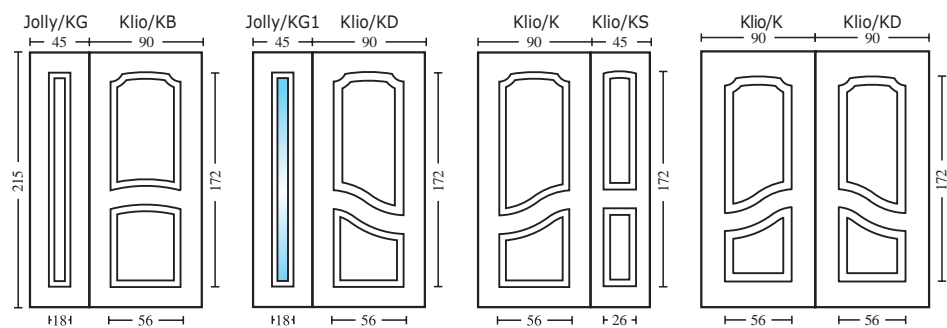

□ A 420



□ A 570



□ A 417



Collezione completa accessori pag. 158-171



□ Mod. LIBRA / K1
Maniglia A 409
Vetro AC

□ Mod. LIBRA / K
Maniglia A 417
Colore Renolit

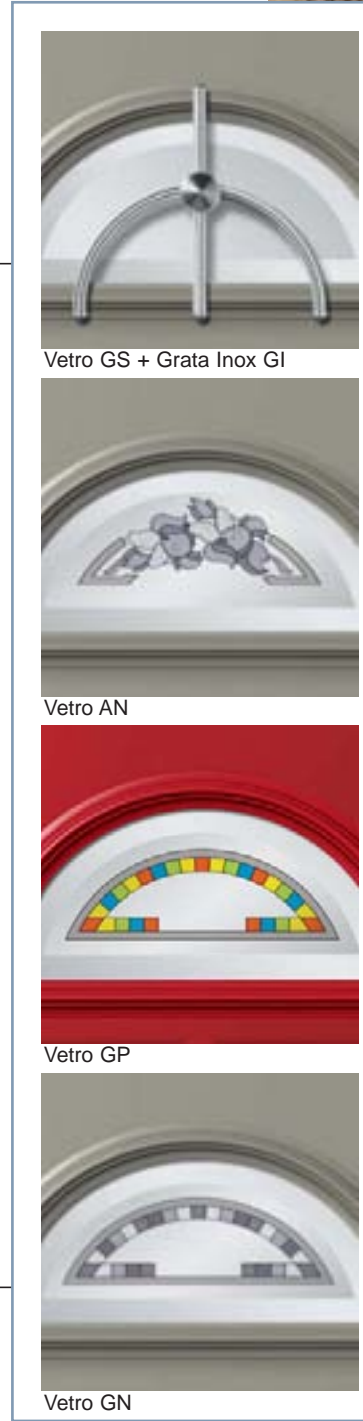

Vetro GS + Grata Inox GI

Vetro AN

Vetro GP

Vetro GN

Varianti e sezioni vetri
pag. 176-177

Mod. LIBRA / K - Maniglia A 409

libra

abbinamenti

accessori

107

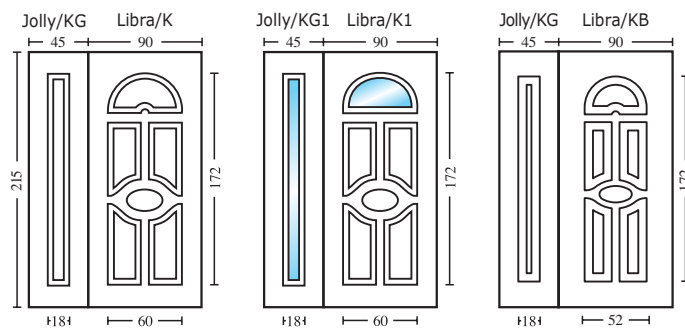

□ A 409



□ A 417



□ A 317



Collezione completa
accessori pag. 158-171



☐ Mod. MINERVA / K
Maniglia A 560

☐ Mod. MINERVA / K1
Maniglia A 460
Vetro GS
Grata inox GI

☐ Mod. MINERVA / KM1
Maniglia A 509
Vetro GN



Varianti e sezioni vetri
pag. 176-177



☐ Mod. MINERVA / KS1 + MINERVA / K1 - Maniglia A 560 - Vetro GP

minerva

abbinamenti

accessori

109

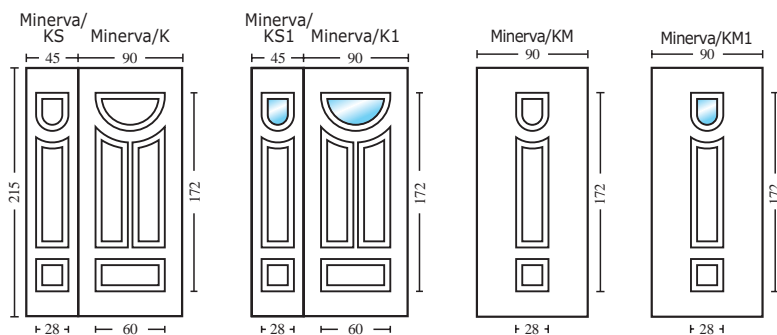

☐ A 509

☐ A 560

☐ A 460



Collezione completa
accessori pag. 158-171



□ Mod. MIRA / K2
Maniglia A 516
Vetro GP

□ Mod. MIRA / K
Maniglia A 514

□ Mod. MIRA / K4
Maniglia A 414
Vetro AC

□ Mod. MIRA / K6
Maniglia A 414
Vetro GP

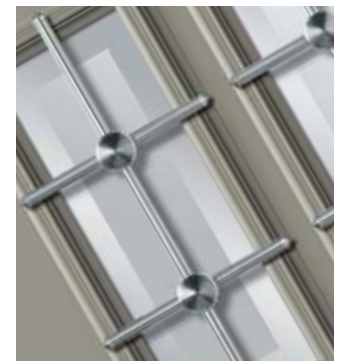

Vetro GS + Grata Inox GI

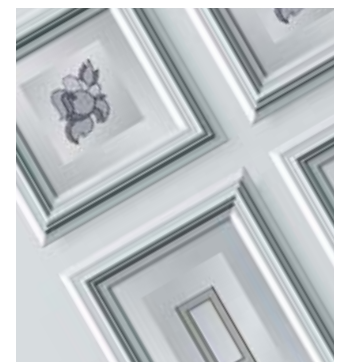

Vetro AN

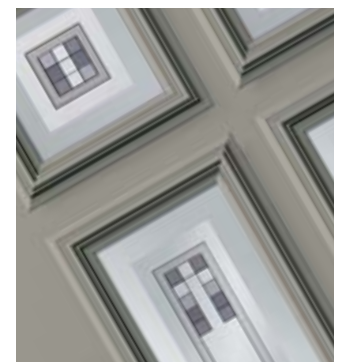

Vetro GN

Varianti e sezioni vetri
pag. 176-177



Mod. MIRA / KS3 + MIRA / K6 - Maniglia A 509 - Vetro GS

mira

abbinamenti

accessori

111

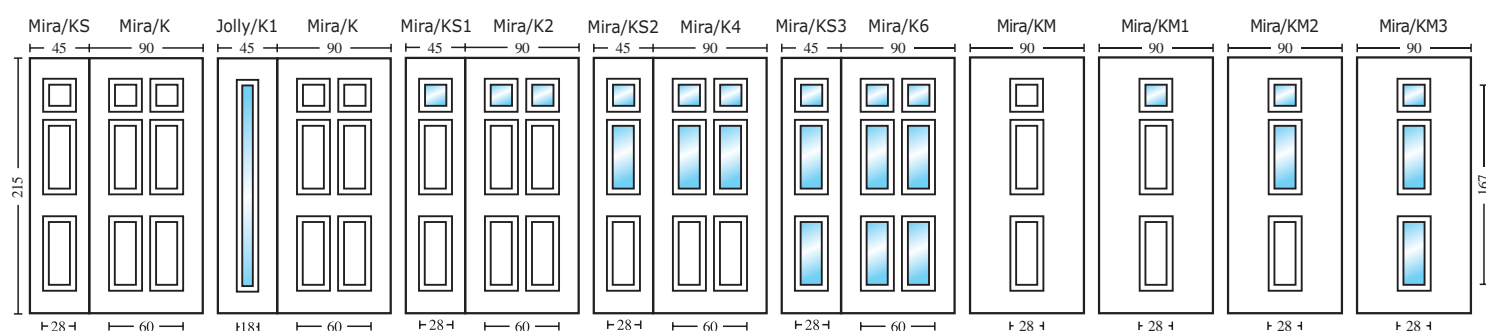

□ A 414

□ A 516

□ A 514

Collezione completa
accessori pag. 158-171





□ Mod. MIRANDA / K
Maniglia A 517

□ Mod. MIRANDA / K1
Maniglia A 570
Vetro AC

□ Mod. MIRANDA / K2
Maniglia A 417
Vetro GS
Grata inox GI



Vetro AN

Vetro GN

Varianti e sezioni vetri
pag. 176-177



Mod. MIRANDA / K3 + Mod. MIRANDA / K3 - Maniglia A 470 - Vetro GP

miranda

abbinamenti

accessori

113

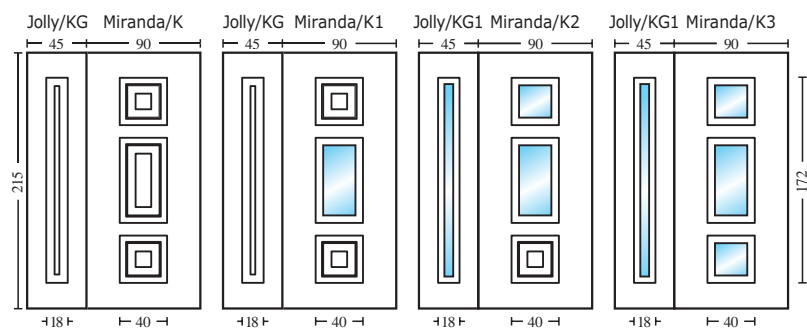

□ A 417

□ A 570

□ A 517

Collezione completa
accessori pag. 158-171





□ Mod. MIRANDA / KB
Maniglia A 509
Battente A 540

□ Mod. MIRANDA / KB1
Maniglia A 317
Vetro AC
Colore Renolit



Vetri AN
Vetro GP
Vetro GN
Varianti e sezioni vetri pag. 176-177



miranda

abbinamenti

accessori

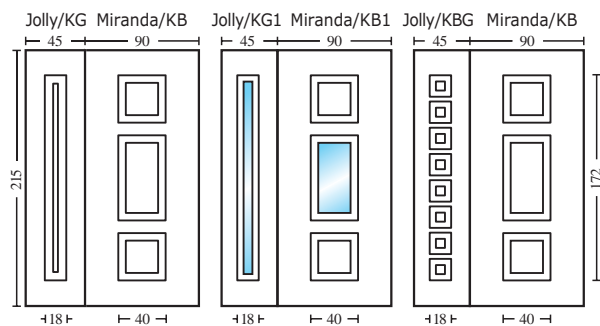

□ A 540



□ A 509



□ A 417



Collezione completa accessori pag. 158-171



Vetro GS + Grata Inox GI



Vetro AN

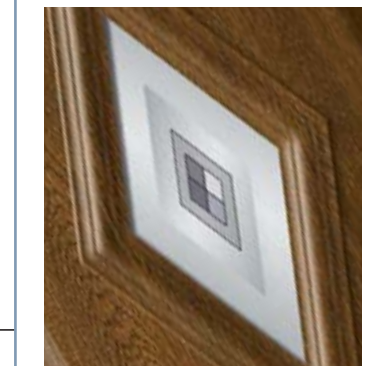

Vetro GN

Varianti e sezioni vetri pag. 176-177



Mod. MIZAR / KS - Mod. MIZAR / K
Maniglia A 514

Mod. MIZAR / K2
Maniglia A 516
Battente A 525
Vetro GP

Mod. NYSA / K
Maniglia A 530

Mod. NYSA / K1
Maniglia A 570
Vetro AC

mizar

abbinamenti

accessori

nysa

abbinamenti

accessori

117

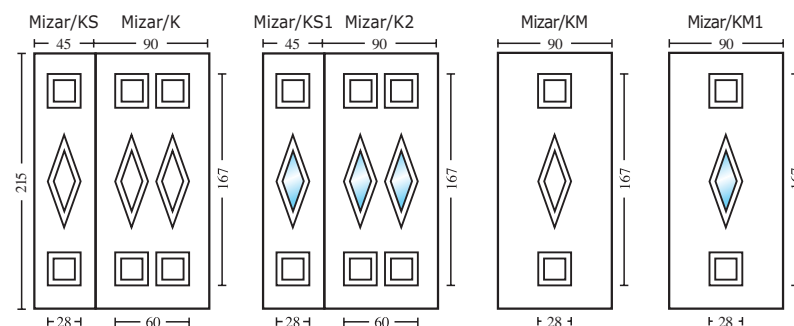

A 540

A 530

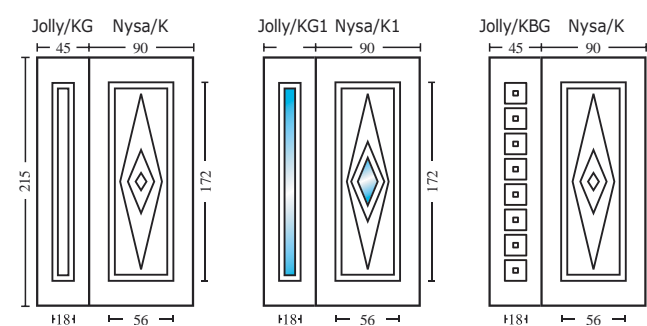

A 514

A 570



Collezione completa accessori pag. 158-171



□ Mod. PALLADIO / K
Maniglia A 506
Battente A 525

□ Mod. PALLADIO / K1
Maniglia A 503
Vetro GS
Grata inox GI

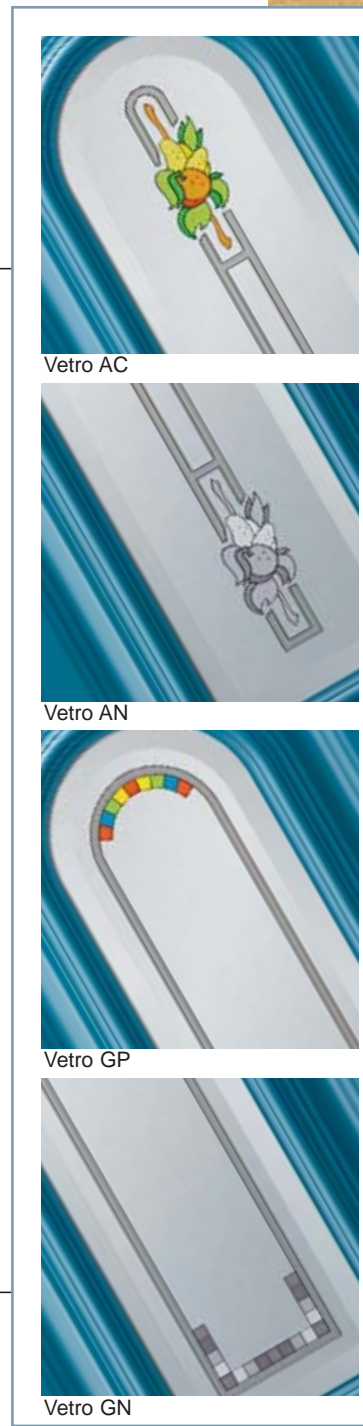

Varianti e sezioni vetri
pag. 176-177



Mod. PALLADIO / K - Maniglia A 406 - Battente A 420

palladio

abbinamenti

accessori

119

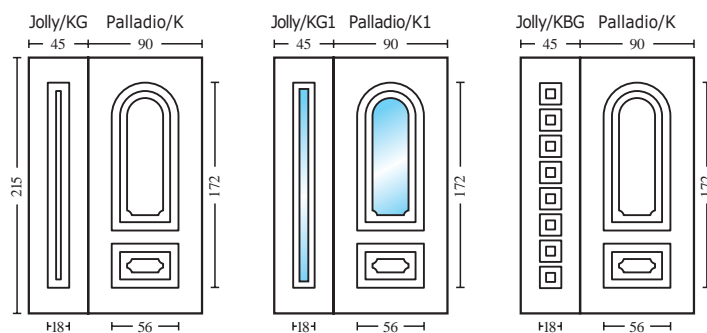

□ A 420



□ A 406



□ A 503



Collezione completa
accessori pag. 158-171



□ Mod. PEGASO / K
Maniglia A 430

□ Mod. PEGASO / K4
Maniglia A 409
Vetro GP

□ Mod. PEGASO / KB
Maniglia A 516

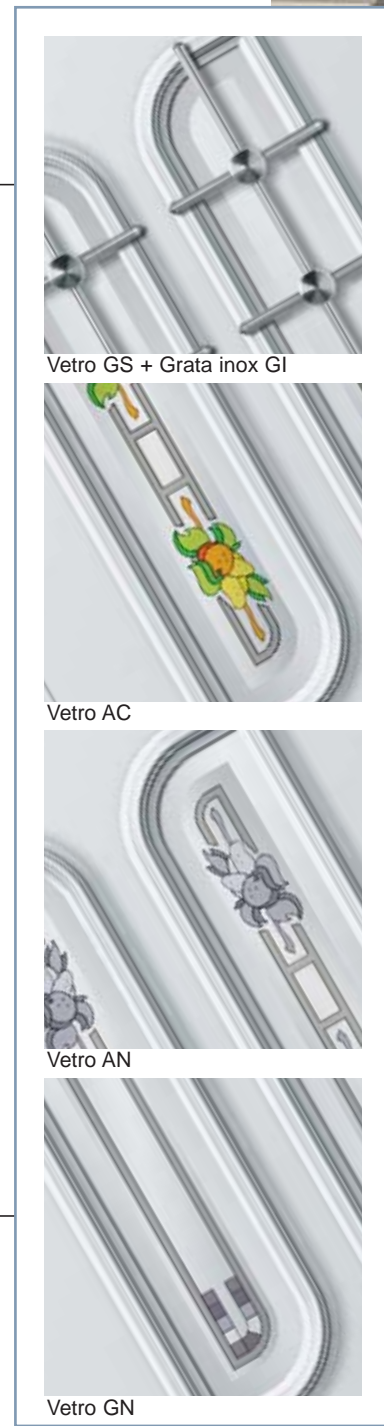

Vetri GS + Grata inox GI
Vetro AC
Vetro AN
Vetro GN
Varianti e sezioni vetri
pag. 176-177

Mod. PEGASO / KM - Maniglia A 430

pegaso

abbinamenti

accessori

121

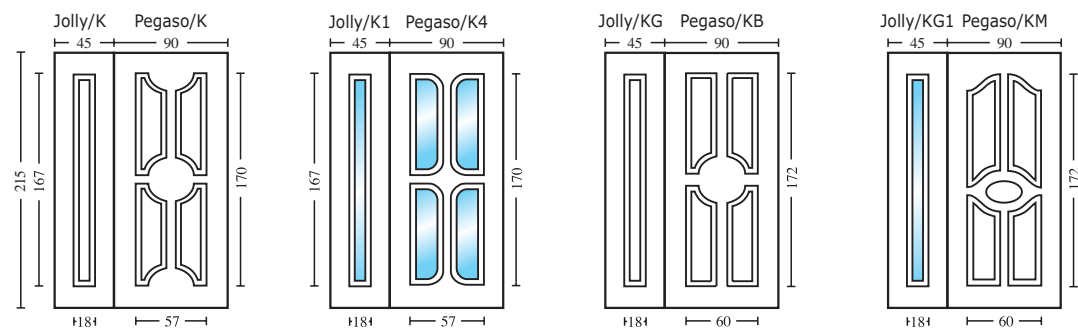

□ A 430



□ A 516



□ A 409



Collezione completa
accessori pag. 158-171



□ Mod. PERSEO / K
Maniglia A 417
Colore Renolit

□ Mod. PERSEO / K1
Maniglia A 414
Vetro GS
Grata Inox GI

□ Mod. PERSEO / K1
Maniglia A 414
Vetro AC

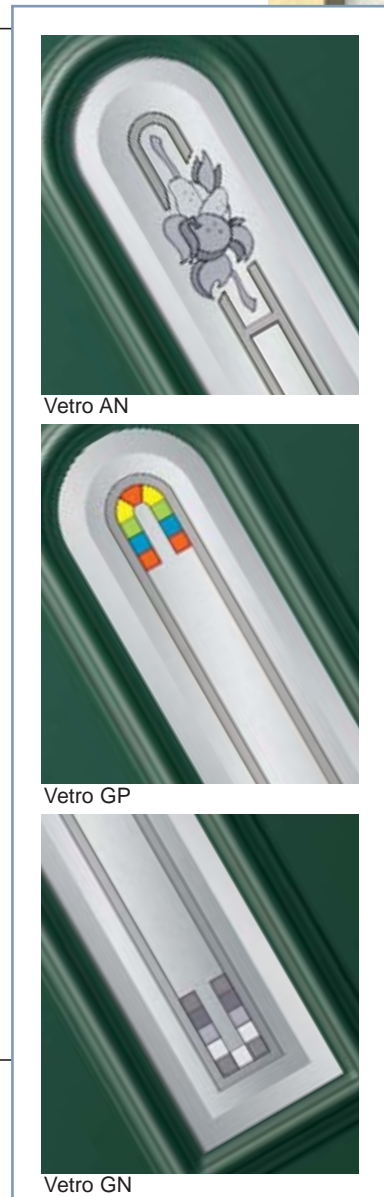

Variante e sezioni vetri
pag. 176-177

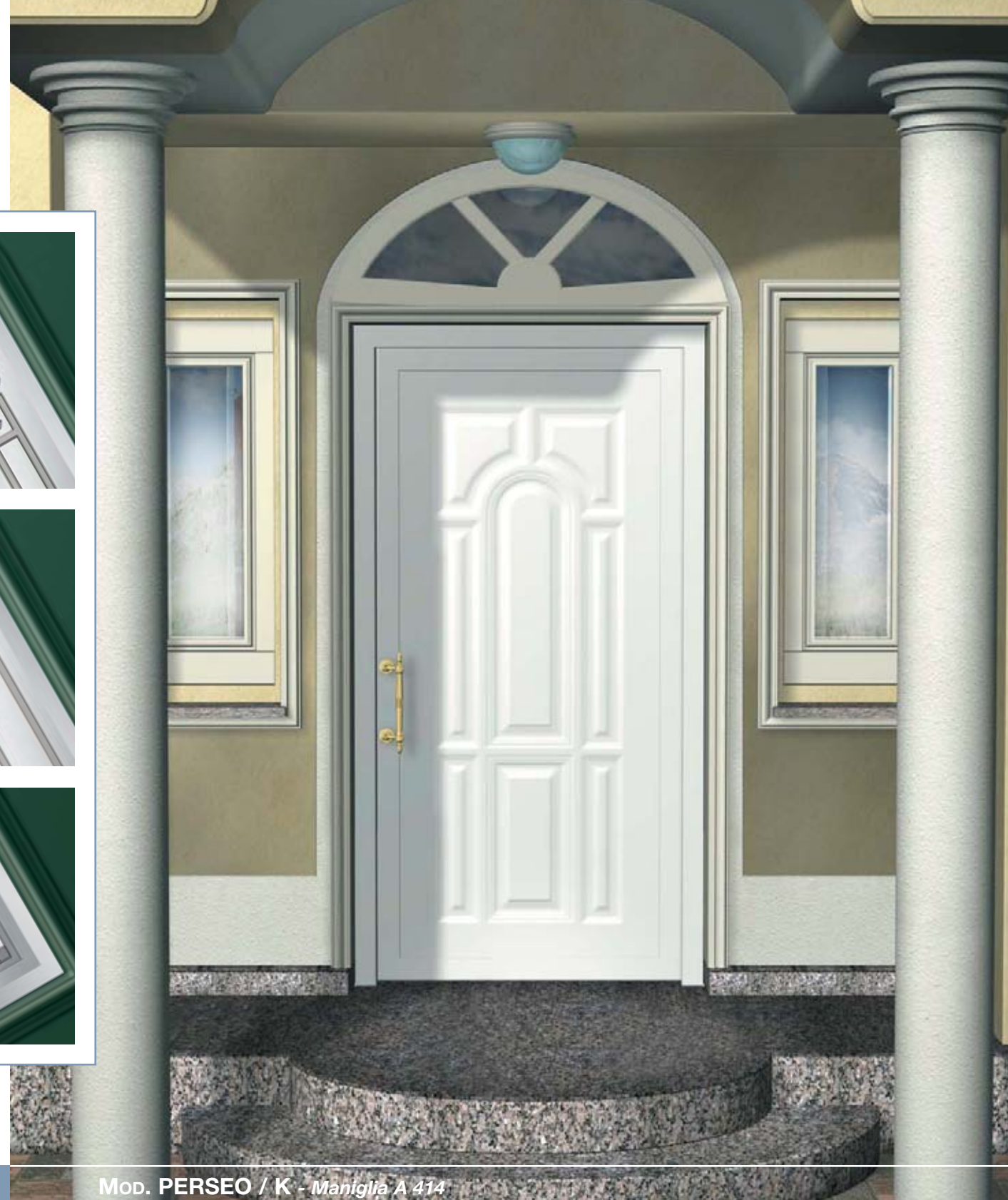

Mod. PERSEO / K - Maniglia A 414

perseo

abbinamenti

accessori

123

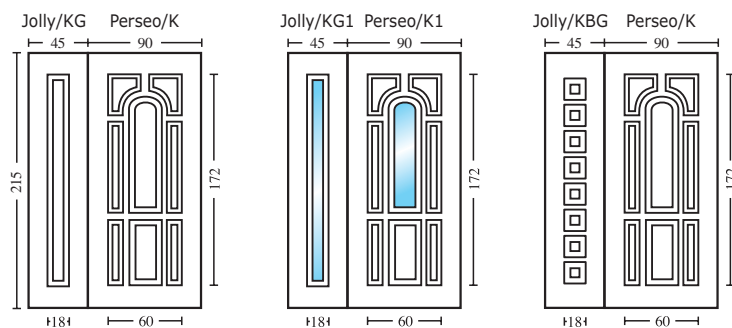

□ A 414

□ A 314

□ A 514

Collezione completa
accessori pag. 158-171





□ Mod. POLARIS / K1
Maniglia A 515
Vetro AC

□ Mod. POLARIS / K2
Maniglia A 515
Vetro GS
Grata Inox GI

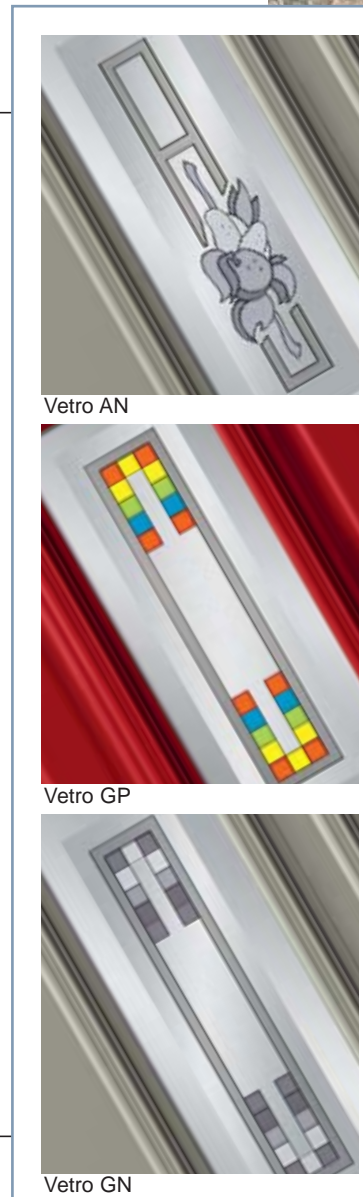

Vetri AN
Vetri GP
Vetri GN
Varianti e sezioni vetri
pag. 176-177



Mod. POLARIS / K - Maniglia A 415 - Battente A 421

polaris

abbinamenti

accessori

125

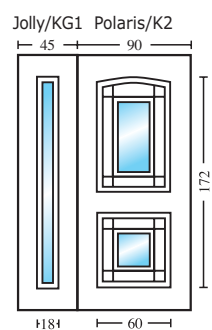
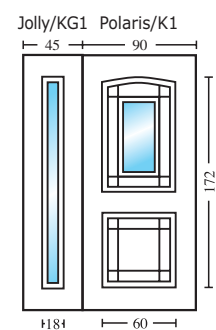
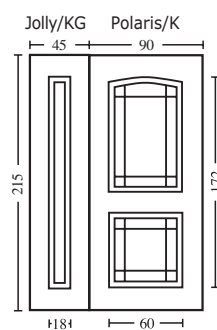

□ A 421



□ A 415



□ A 515



Collezione completa
accessori pag. 158-171



□ Mod. QUASAR / K
Maniglia A 414
Battente A 425

□ Mod. QUASAR / K1
Maniglia A 416
Vetro AC

□ Mod. QUASAR / K3
Maniglia A 414
Vetro GP



Vetro GS + Grata Inox GI



Vetro AN



Vetro GN

Varianti e sezioni vetri
pag. 176-177



Mod. QUASAR / K3 - Maniglia A 509 - Vetro AC

quasar

abbinamenti

accessori

127

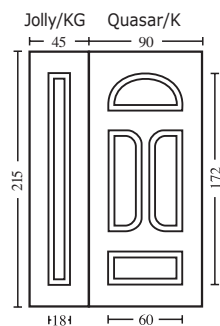

□ A 425



□ A 414



□ A 416

Collezione completa
accessori pag. 158-171



□ Mod. REGOLO / KA
Maniglia A 570

□ Mod. REGOLO / KB
Maniglia A 515
Battente A 521

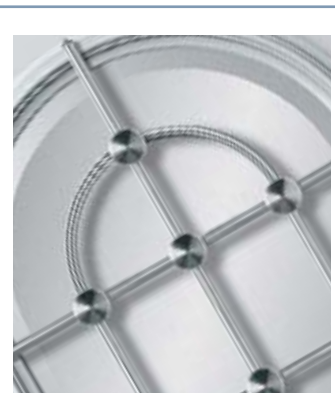

Vetro GS + Grata Inox GI



Vetro AN



Vetro GP

Varianti e sezioni vetri
pag. 176-177



□ Mod. ALFAIR / KS1 + REGOLO / KA1
Maniglia A 414
Vetro AC

regolo

abbinamenti

accessori

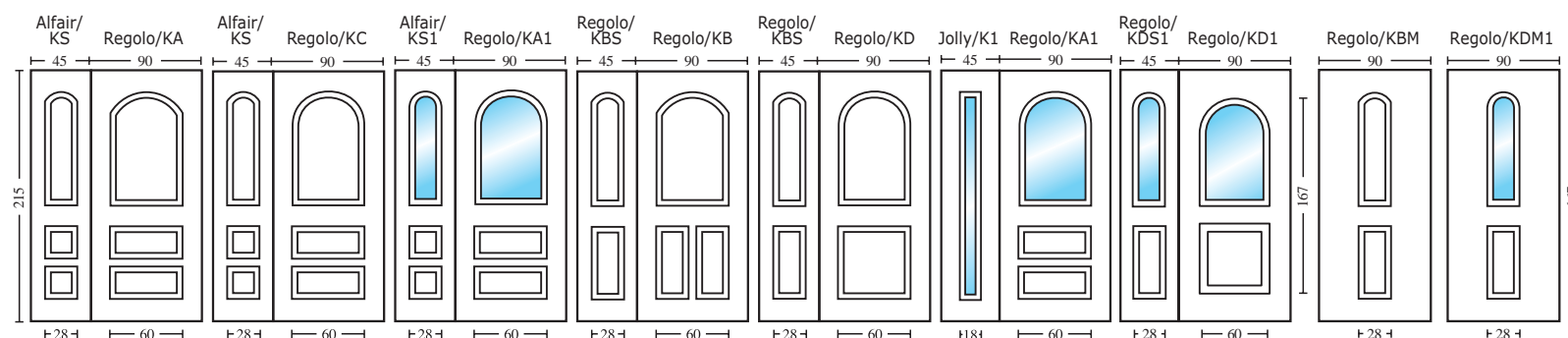

□ A 521



□ A 515



□ A 570



Collezione completa
accessori pag. 158-171



Mod. REGOLO / KC
Maniglia A 509
Battente A 520

Mod. REGOLO / KD
Maniglia A 409
Battente A 440

Mod. REGOLO / KD1
Maniglia A 409
Vetro GP

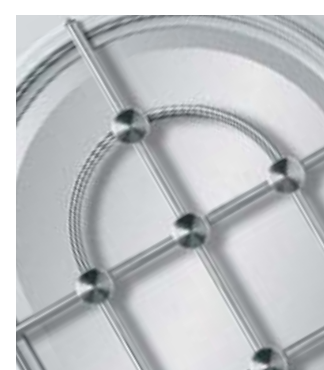

Vetro GS + Grata Inox GI



Vetro AN

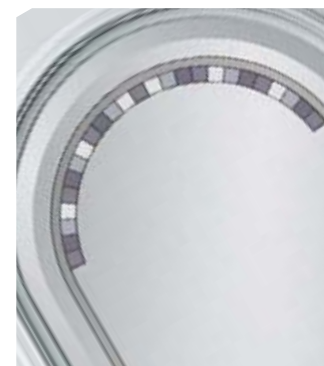

Vetro GN

Varianti e sezioni vetri
pag. 176-177



regolo

abbinamenti

accessori

131

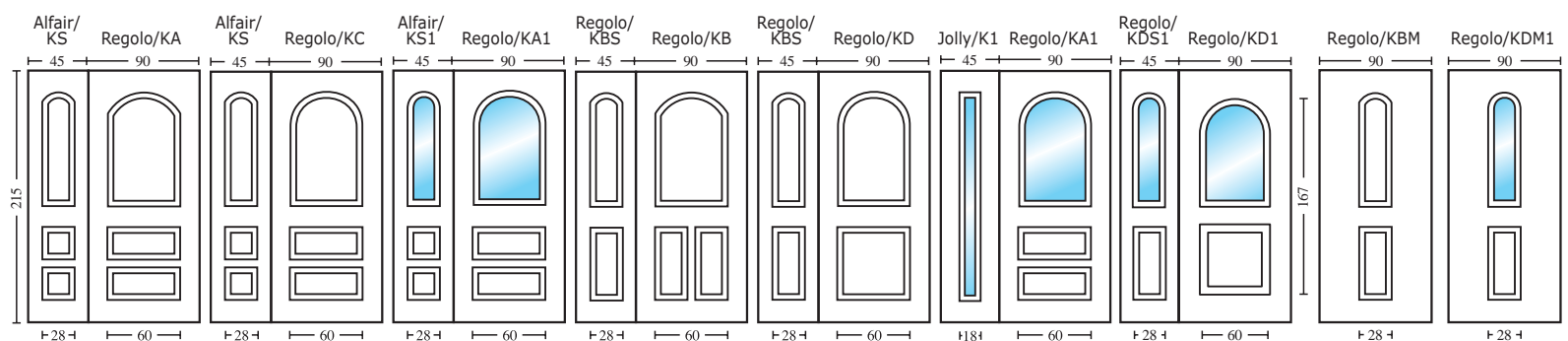

A 440



A 509



A 409



Collezione completa
accessori pag. 158-171



□ Mod. RIGEL / K
Maniglia A 514

□ Mod. RIGEL / K2
Maniglia A 414
Vetro GP

□ Mod. RIGEL / KB
Maniglia A 417
Battente A 440



Vetro GS + Grata Inox GI



Vetro AN



Vetro GN

Varianti e sezioni vetri
pag. 176-177



Mod. RIGEL / KM1 - Maniglia A 518 - Vetro AC

rigel

abbinamenti

accessori

133

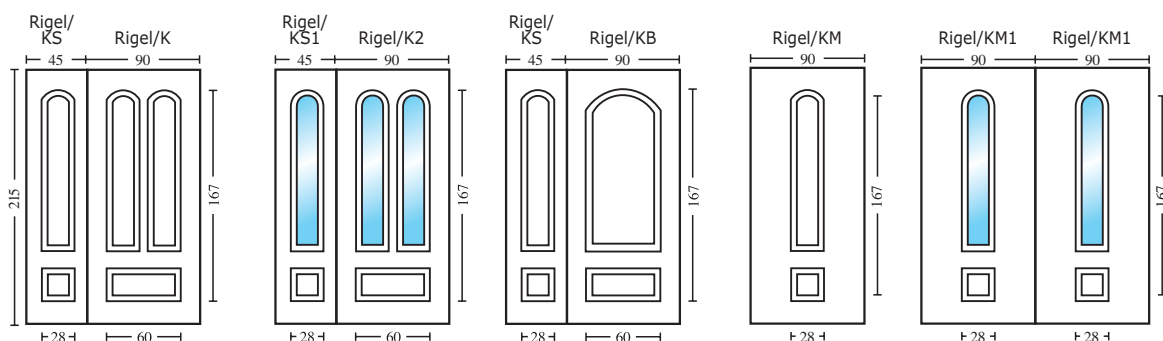

□ A 440



□ A 417



□ A 514



Collezione completa
accessori pag. 158-171



□ Mod. SIGMA / KB1
Maniglia A 416
Vetro GP

□ Mod. SIGMA / KB1
Maniglia A 416
Vetro AN



Vetro GN

Varianti e sezioni vetri
pag. 176-177



Mod. SIGMA / KB1 + Mod. SIGMA / KB1 - Maniglia A 560 - Vetro AC

sigma

abbinamenti

accessori

135

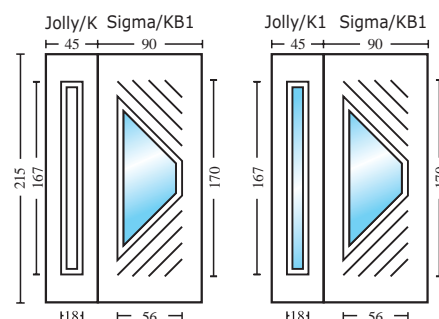

□ A 516

□ A 416

□ A 560

Collezione completa
accessori pag. 158-171





□ Mod. SIRIO / K
Maniglia A 415
Maniglia A 421

□ Mod. SIRIO / KC
Maniglia A 409

□ Mod. SIRIO / KE
Maniglia A 514



Vetro GS + Grata Inox GI



Vetro AC



Vetro AN



Vetro GN

Varianti e sezioni vetri
pag. 176-177

Mod. SIRIO / K1 - Maniglia A 470 - Vetro GP



sirio

abbinamenti

accessori

137

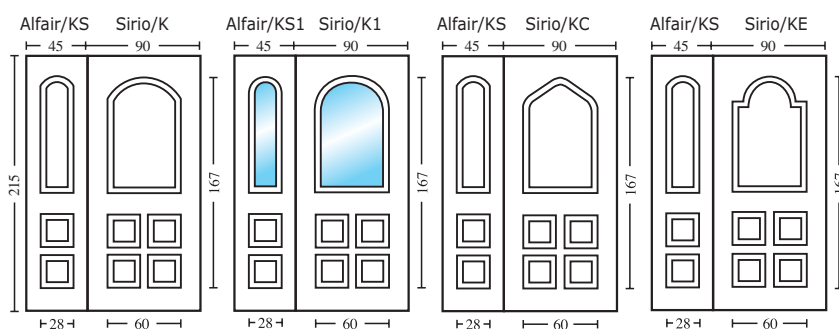

□ A 421



□ A 415



□ A 470



Collezione completa
accessori pag. 158-171



□ Mod. SPIGA / KD
Maniglia A 517

□ Mod. SPIGA / KA - Mod. SPIGA / KB
Maniglia A 515

Mod. SPIGA / KAS + SPIGA / KE - Maniglia A 415

spiga

abbinamenti

accessori

139

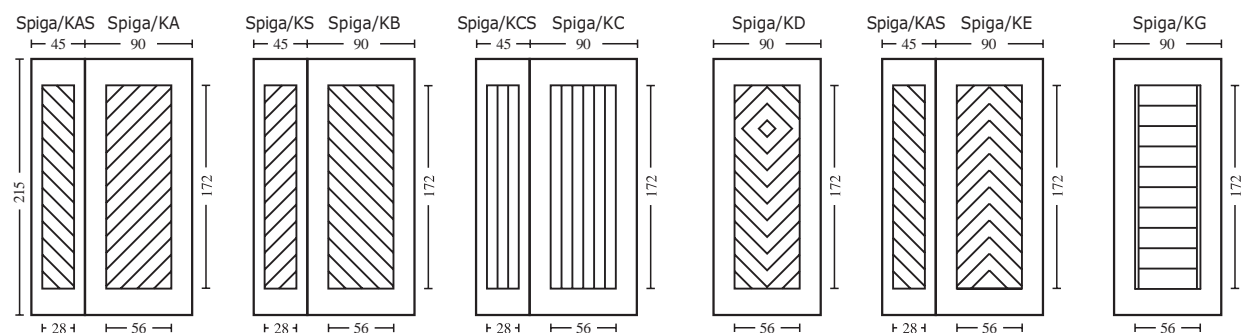

□ A 517

□ A 515

□ A 415

Collezione completa accessori pag. 158-171





□ Mod. SPIGA / KL - Mod. SPIGA / KM
Maniglia A 409

□ Mod. SPIGA / KMS - Mod. SPIGA / KM
Maniglia A 516



Mod. SPIGA / KI - Maniglia A 414

spiga

abbinamenti

accessori

141

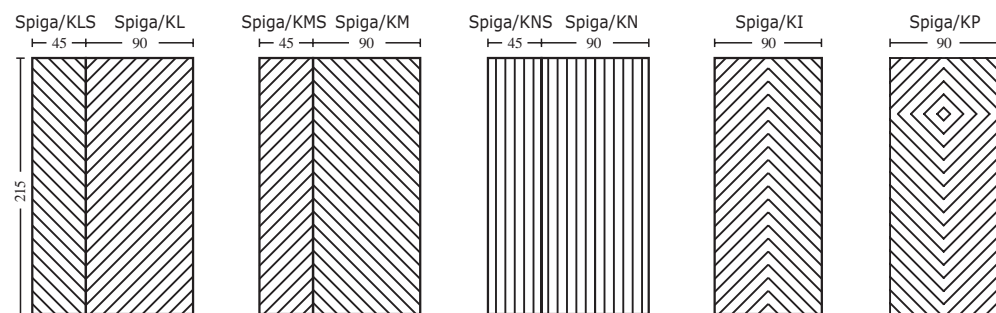

Non disponibili nei colori:
verniciato legno, Renolit e anodizzati.
Non producibili di spessore inferiore a 7 mm.

Not available in wood colours,
Renolit and anodized colours.

□ A 409



□ A 516



□ A 414



Collezione completa
accessori pag. 158-171



□ Mod. STILUS / K1
Maniglia A 517
Vetro GP

□ MOD. JOLLY / KG1 + Mod. STILUS / K1 + MOD. JOLLY / KG1
Maniglia A 416
Vetro GS + AC + GS



Vetro GS + Grata Inox GI



Vetro AN

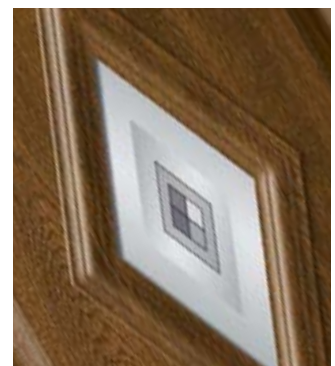

Vetro GN

Varianti e sezioni vetri
pag. 176-177



Mod. STILUS / K - Maniglia A 517

stilus

abbinamenti

vetri

143

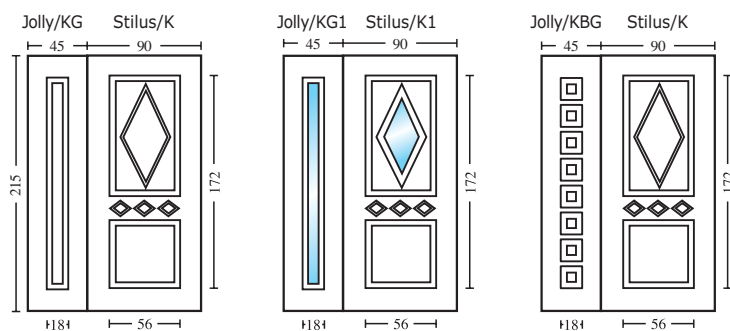

□ A 416

□ A 517

□ A 316

Collezione completa
accessori pag. 158-171





□ Mod. TITANO / K2
Maniglia A 470
Vetro AC

□ Mod. TITANO / K
Maniglia A 406



Vetro GS + Grata Inox GI

Vetro AN

Vetro GP

Vetro GN

Varianti e sezioni vetri
pag. 176-177



Mod. TITANO / K2 - Maniglia A 570 - Vetro GS

titano

abbinamenti

accessori

145

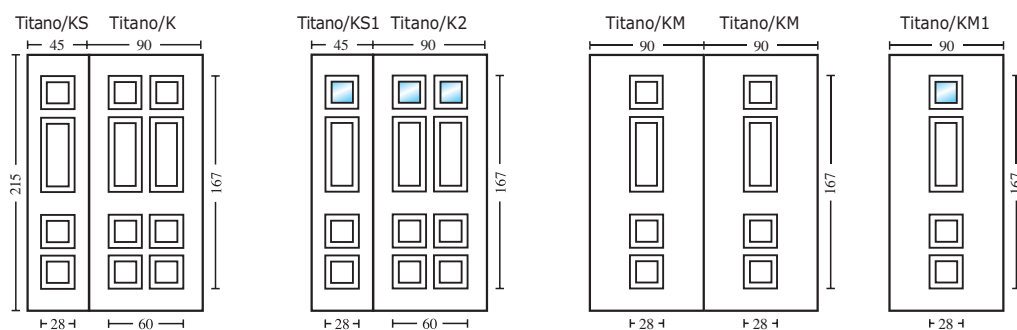

□ A 470

□ A 570

□ A 406

Collezione completa
accessori pag. 158-171





☐ Mod. TRIADE / KB
Maniglia A 314
Colore Renolit

☐ Mod. TRIADE / K1
Maniglia A 409
Vetro AC

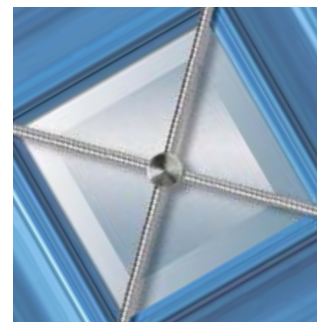

Vetro GS + Grata Inox GI



Vetro AN



Vetro GP

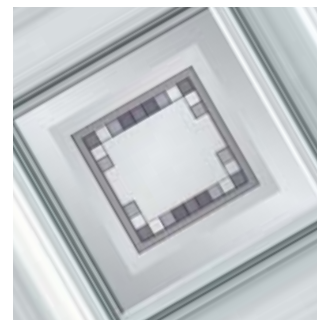

Vetro GN

Varianti e sezioni vetri
pag. 176-177



Mod. TRIADE / K - Maniglia A 515 - Battente A 521

triade

abbinamenti

accessori

147

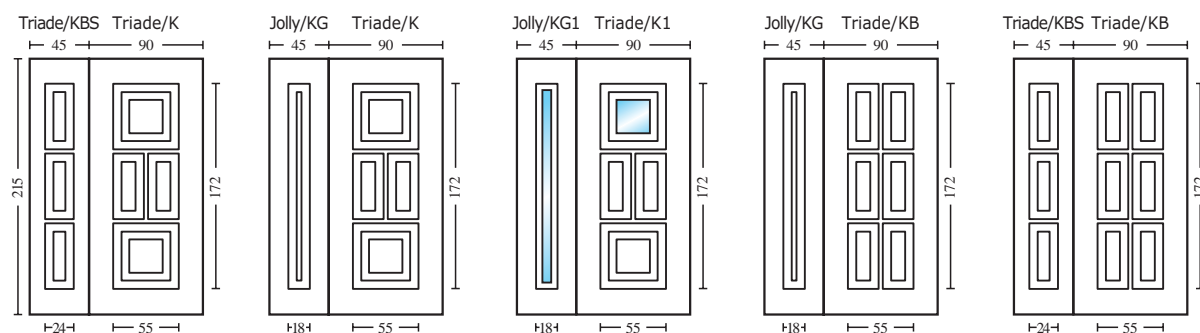

☐ A 521



☐ A 515



☐ A 409



Collezione completa
accessori pag. 158-171



□ Mod. VEGA / K4
Maniglia A 570
Vetro GP

□ Mod. VEGA / KM2
Maniglia A 503
Vetro AN



Vetro GS + Grata Inox GI

Vetro AC

Vetro GN

Varianti e sezioni vetri
pag. 176-177



Mod. URANIA / K - Maniglia A 417 - Battente 420

vega

abbinamenti

accessori

urania

abbinamenti

accessori

149

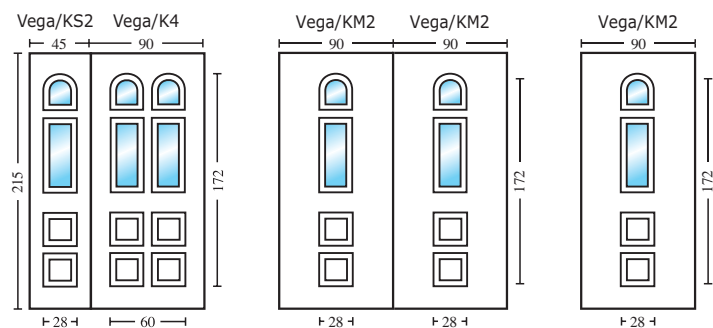

□ A 570

□ A 503

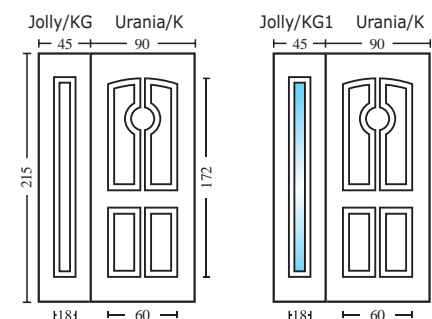

□ A 420

□ A 417



Collezione completa
accessori pag. 158-171



□ Mod. VICTORIA / K
Maniglia A 517

□ Mod. VICTORIA / K1
Maniglia A 417
Vetro AC



Vetro AN



Vetro GN



Vetro GP

Varianti e sezioni vetri
pag. 176-177



Mod. VICTORIA / K1 - Maniglia A 514 - Vetro GS - Grata Inox GI

victoria

abbinamenti

accessori

151

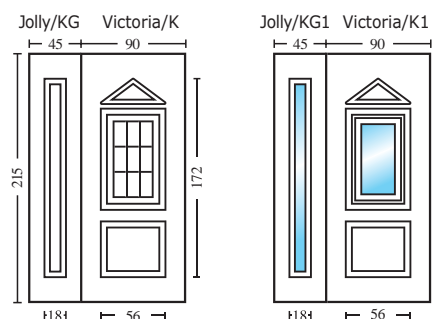

□ A 517

□ A 417

□ A 514

Collezione completa
accessori pag. 158-171



exit



Non solo porte d'ingresso per abitazioni: con il programma Exit le vostre esigenze prendono finalmente forma. Porte di servizio di edifici pubblici, industriali, e commerciali possono contare su un prodotto innovativo, con soluzioni inedite e dal design essenziale. Exit coniuga soluzioni estetiche e versatilità come nella tradizione dei prodotti Aluform.

Not only front doors for Your home: your requirements take shape with the Exit program finally. Back-doors of public building, manufacturers, and trade can make confidence on an innovative product, with new solutions and essential design. Exit joins beauty and versatility solutions, like in the tradition of all Aluform products.

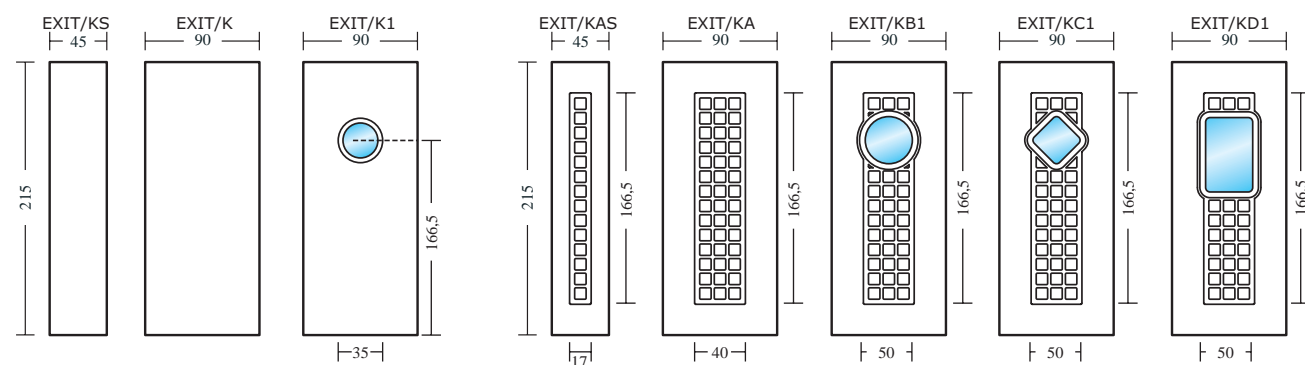

Tipo M

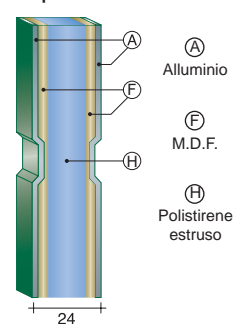

Vetro standard stratificato da 10 mm trasparente

(Il vetro è inserito nel pannello in fase di assemblaggio e non è sostituibile successivamente, tranne che per il modello EXIT/K1)



- ▶ Ottone PVD
- ▶ Ottone Classico
- ▶ Cromo Satinato
- ▶ Acciaio Inox

accessori



Per la vostra porta chiedete sempre accessori originali Aluform. Le nostre proposte non sono mai affidate al caso: da sempre selezioniamo i migliori prodotti per garantirvi coerenza nel design ma anche e soprattutto funzionalità ed inalterabilità nel tempo.

For Your door, demand always Aluform original accessories. Our propose are never entrusted to the case: we select always the best products to guarantee an harmony design but also and above functional and unchanging characteristics in the long run.

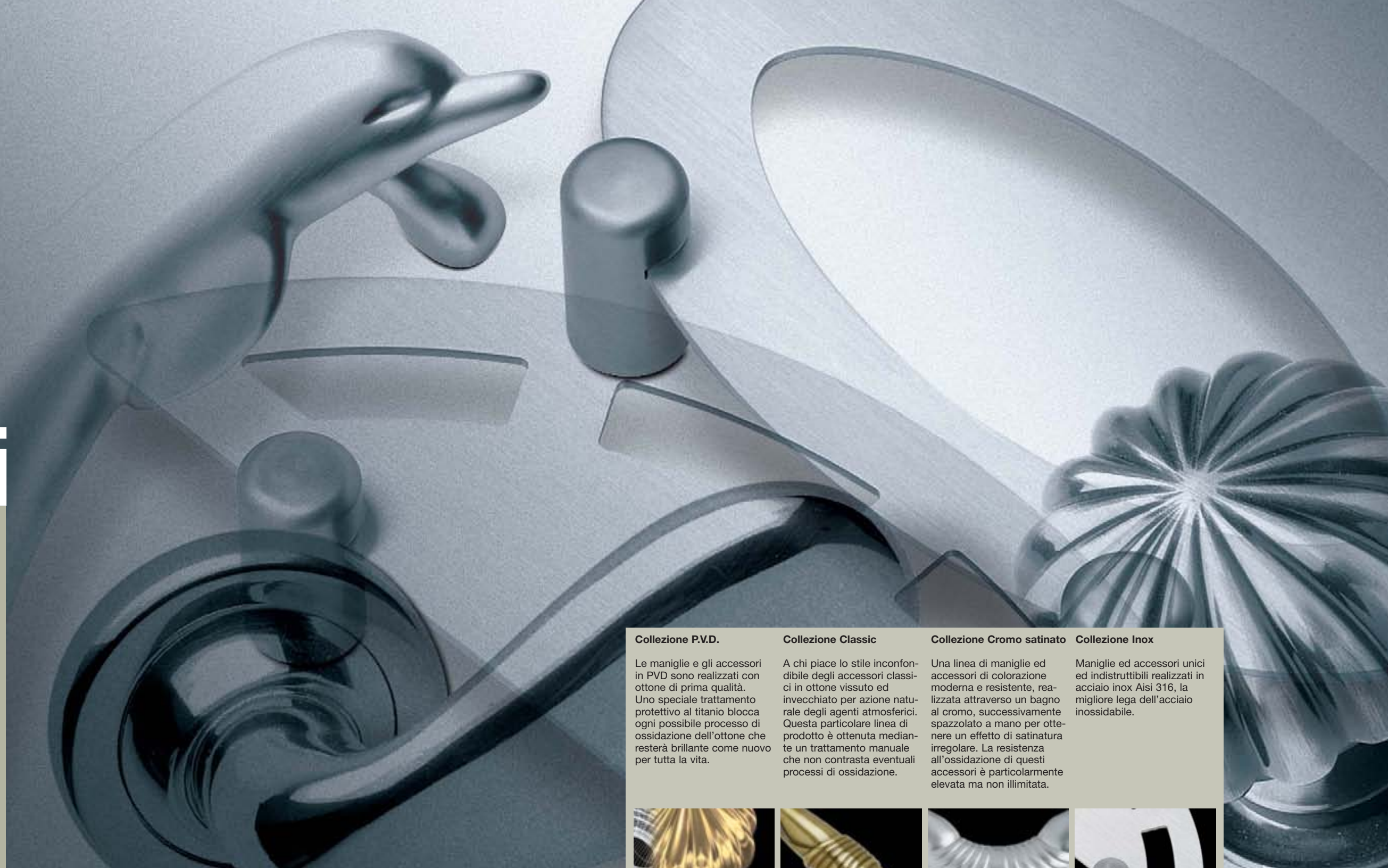

Collezione P.V.D.

Le maniglie e gli accessori in PVD sono realizzati con ottone di prima qualità. Uno speciale trattamento protettivo al titanio blocca ogni possibile processo di ossidazione dell'ottone che resterà brillante come nuovo per tutta la vita.

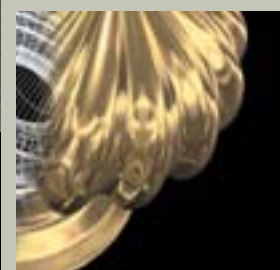

P.V.D. Collection

Our PVD handles and accessories are made with best quality brass. A special titanium protecting treatment blocks every possible oxidation process of the brass that will be bright like a new one and for all its life.

Collezione Classic

A chi piace lo stile inconfondibile degli accessori classici in ottone vissuto ed invecchiato per azione naturale degli agenti atmosferici. Questa particolare linea di prodotto è ottenuta mediante un trattamento manuale che non contrasta eventuali processi di ossidazione.

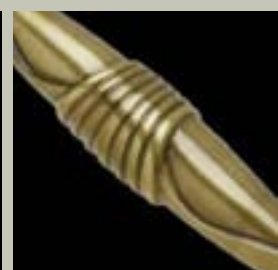

Classic Collection

The brand for every one loves the unmistakable style of classic accessories in lived and aged brass by share natural of the atmospheric agents. This particular line of product is obtained by means of a manual treatment that does not contrast the eventual processes of oxidation.

Collezione Cromo satinato

Una linea di maniglie ed accessori di colorazione moderna e resistente, realizzata attraverso un bagno al cromo, successivamente spazzolato a mano per ottenere un effetto di satinatura irregolare. La resistenza all'ossidazione di questi accessori è particolarmente elevata ma non illimitata.

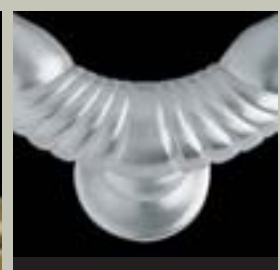

Satinated-Chrome Collection

A brand of handles and accessories of realized modern and resistant coloration through a chrome-bath and brushed by hand subsequently, to obtain an irregular effect of glazing. The resistance to the oxidation of these accessories is particularly elevated but not limitless.

Collezione Inox

Maniglie ed accessori unici ed indistruttibili realizzati in acciaio inox Aisi 316, la migliore lega dell'acciaio inossidabile.



Inox Collection

Only and indestructible handles and accessories realize in stainless steel Aisi 316, the best alloy of the stainless steel.



A 415

A 416

A 417

A 470

A 414

A 409

A 460

A 406

accessori

ottone PVD

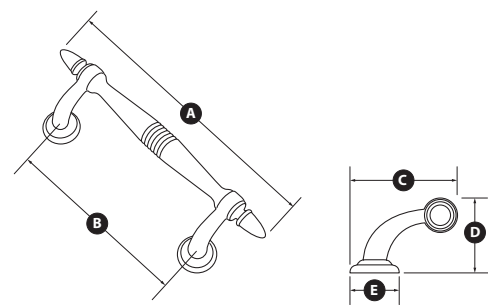

articolo misure (mm) attacco

articolo	misure (mm)					attacco
	A	B	C	D	E	
A. 406	295	230	80	75	37	R - P
A. 409	320	280	80	88	45	R - P
A. 414	336	230	90	68	44	R - P
A. 415	315	235	90	68	44	R - P
A. 416	307	230	90	68	44	R - P
A. 417	309	230	90	68	44	R - P
A. 460	260	215	115	79	45	R - P
A. 470	340	235	94	73	44	R - P

attacco con rosetta · R

attacco passante · P



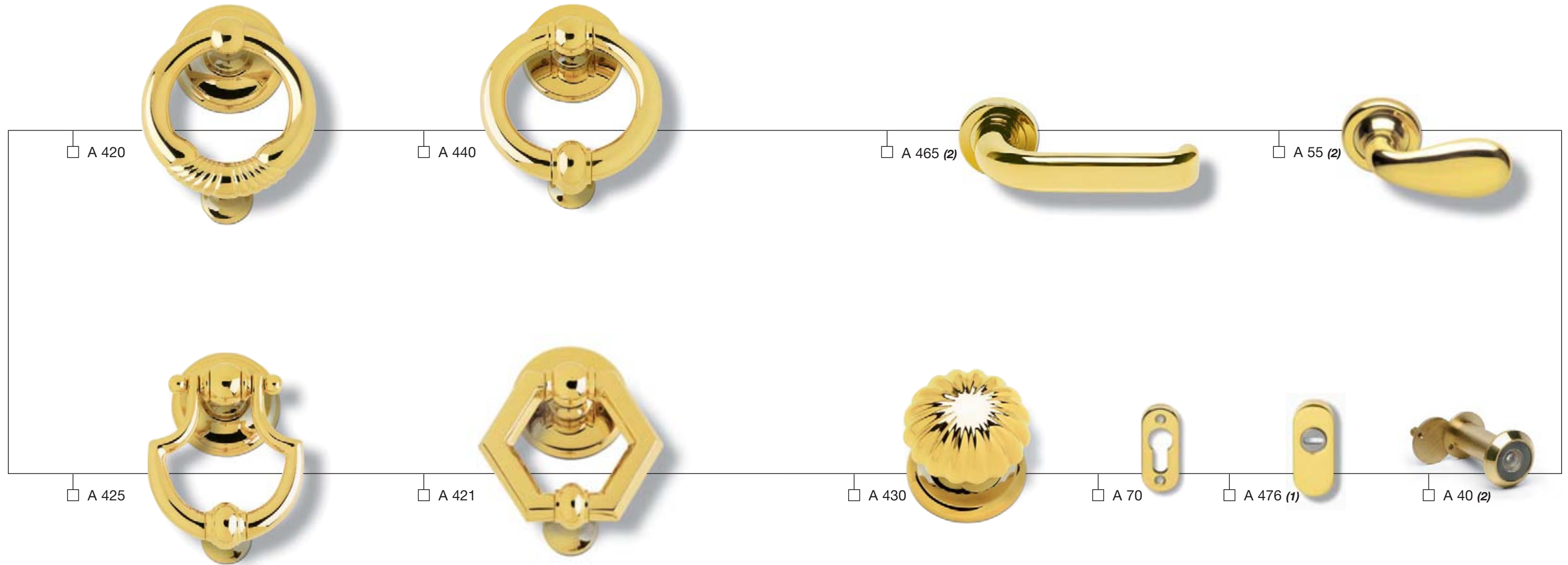

accessori

ottone PVD

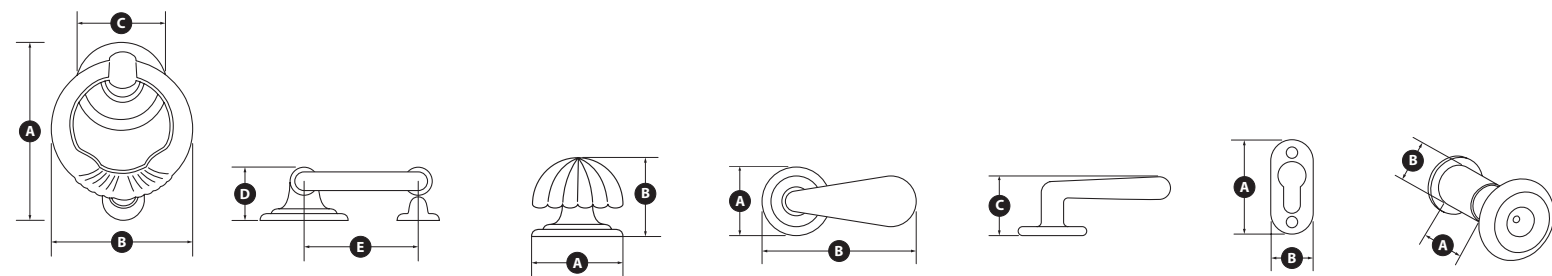

articolo misure (mm) attacco

articolo	misure (mm)					attacco
	A	B	C	D	E	
A. 40	18/45	14
A. 55	50	104	60	.	.	.
A. 70	67	27
A. 420	155	118	79	60	100	R
A. 421	142	115	79	58	87	R
A. 425	163	110	79	63	107	R
A. 430	81	83	.	.	.	R
A. 440	165	135	79	58	110	R
A. 465	50	150	66	.	.	.
A. 476	70	30

attacco con rosetta · R

attacco passante · P



(1) Per utilizzare il DEFENDER, il cilindro deve sporgere dalla porta da 8 a 10 mm.

(2) Questi articoli non hanno il trattamento PVD

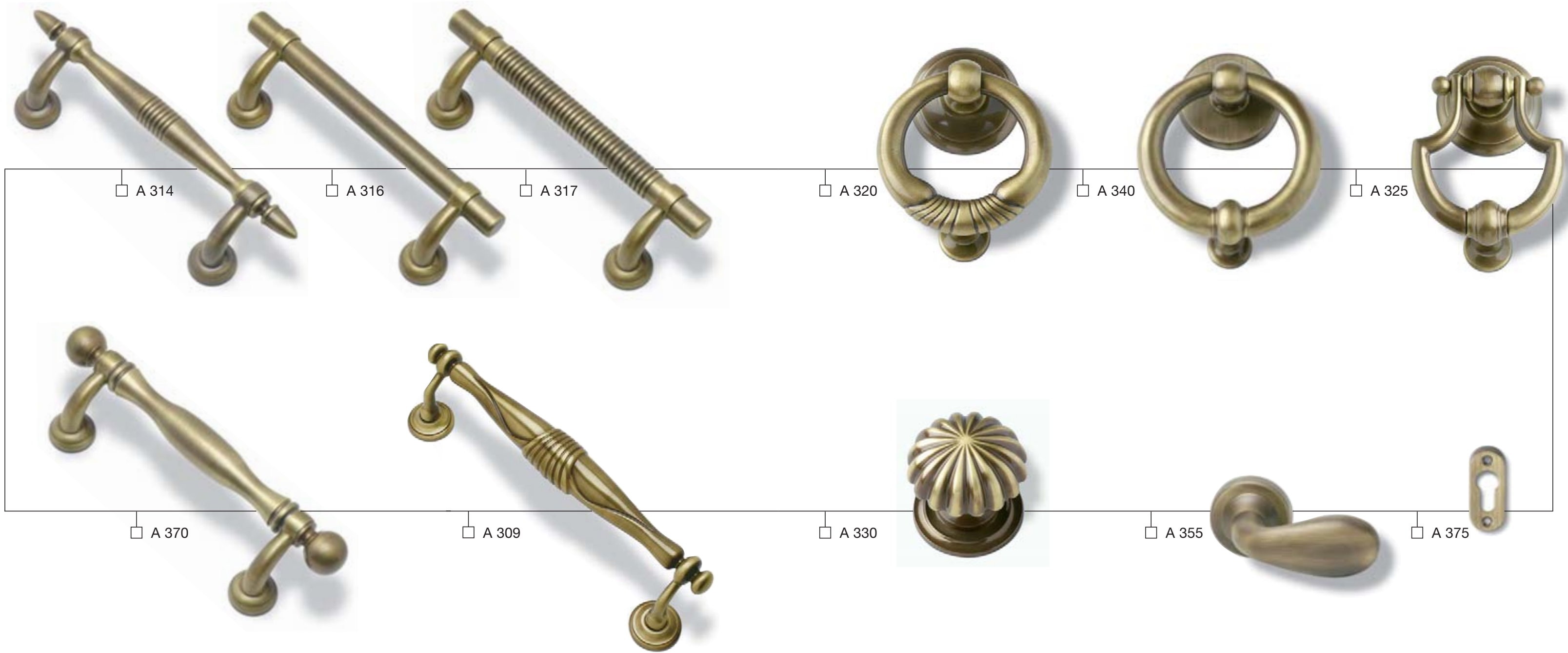

accessori

ottone classico

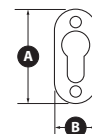
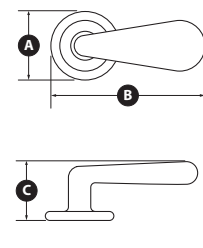
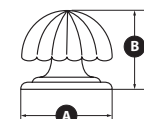
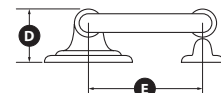
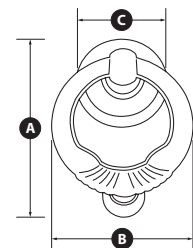
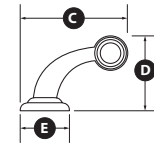
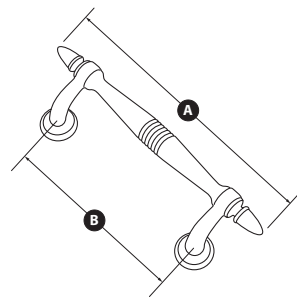

articolo	misure (mm)					attacco
	A	B	C	D	E	
A. 309	320	280	80	88	45	R - P
A. 314	336	230	90	68	44	R - P
A. 316	307	230	90	68	44	R - P
A. 317	309	230	90	68	44	R - P
A. 320	155	118	79	60	100	R
A. 325	163	110	79	63	107	R
A. 330	81	83	.	.	.	R
A. 340	165	135	79	58	110	R
A. 355	50	104	60	.	.	.
A. 370	340	235	94	73	44	R - P
A. 375	67	27

attacco con rosetta · R

attacco passante · P





accessori

cromo satinato

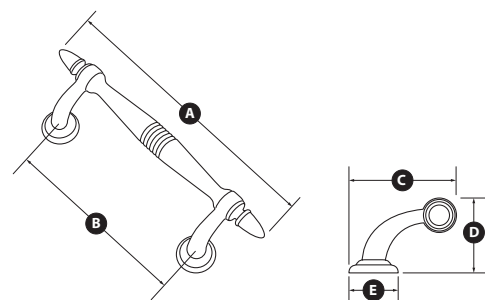

articolo misure (mm) attacco

articolo	misure (mm)					attacco
	A	B	C	D	E	
A. 502	360	300	130	70	60	P
A. 503	360	300	130	70	60	P
A. 506	295	230	80	75	37	R - P
A. 509	320	280	80	88	45	R - P
A. 514	336	230	90	68	44	R - P
A. 515	315	235	90	68	44	R - P
A. 516	307	230	90	68	44	R - P
A. 517	309	230	90	68	44	R - P
A. 560	260	215	115	79	45	R - P
A. 570	340	235	94	73	44	R - P

attacco con rosetta · R

attacco passante · P



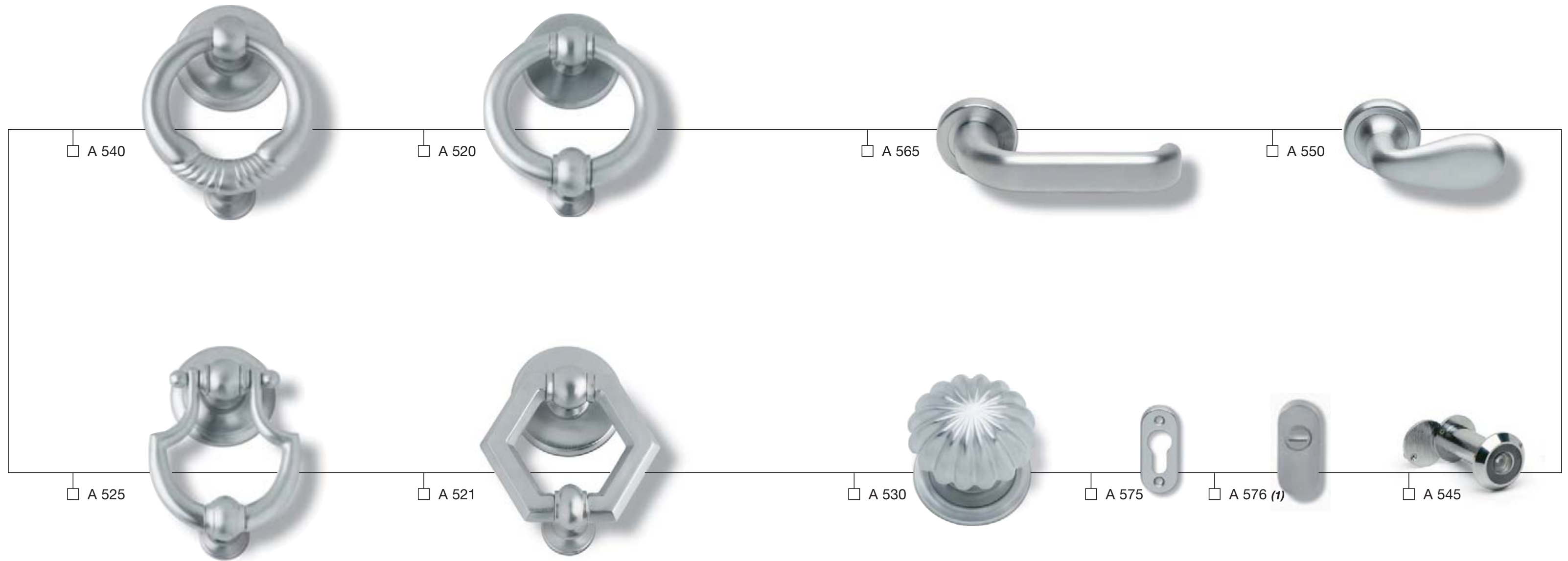

accessori

cromo satinato

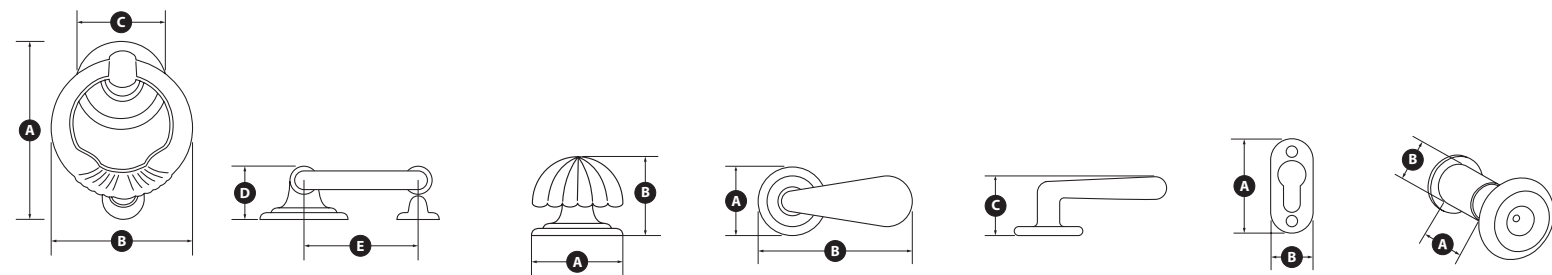

articolo misure (mm) attacco

articolo	misure (mm)					attacco
	A	B	C	D	E	
A. 520	165	135	79	58	110	R
A. 521	142	115	79	58	87	R
A. 525	163	110	79	63	107	R
A. 530	81	83	.	.	.	R
A. 540	155	118	79	60	100	R
A. 545	18/45	14
A. 550	50	104	60	.	.	.
A. 565	50	150	66	.	.	.
A. 575	67	27
A. 576	70	30

attacco con rosetta · R



(1) Per utilizzare il DEFENDER, il cilindro deve sporgere dalla porta da 8 a 10 mm.

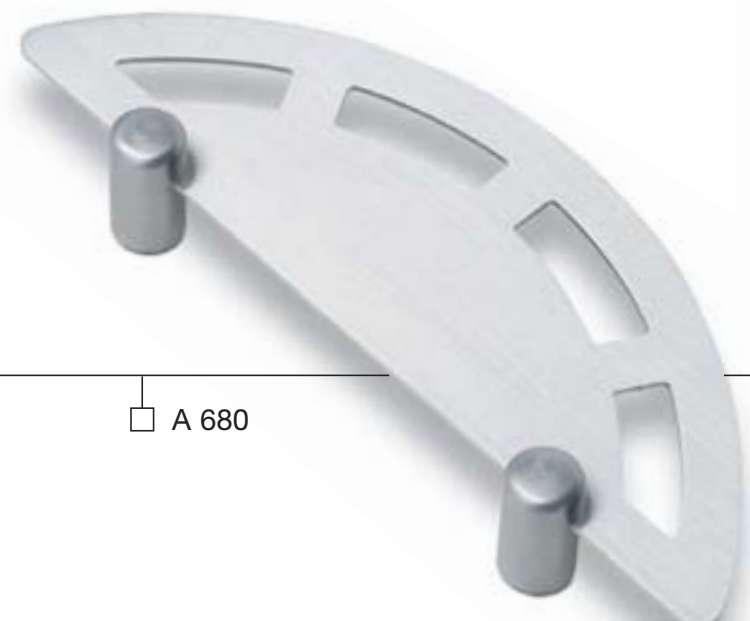

A 680

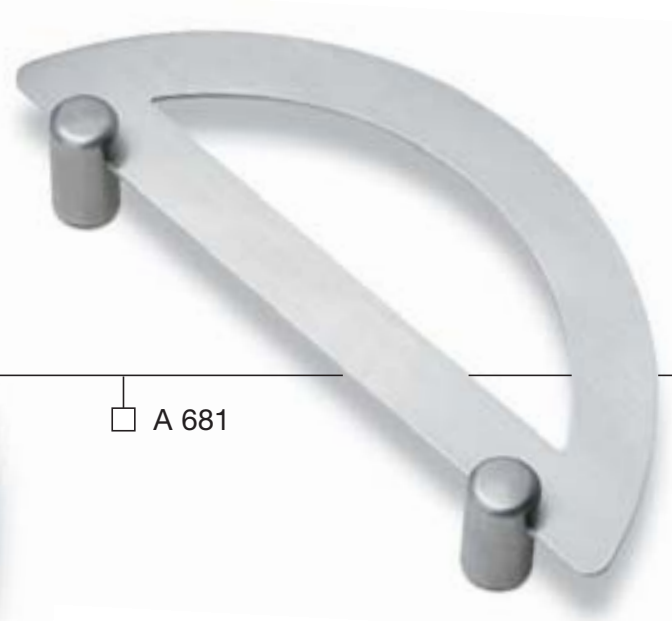

A 681

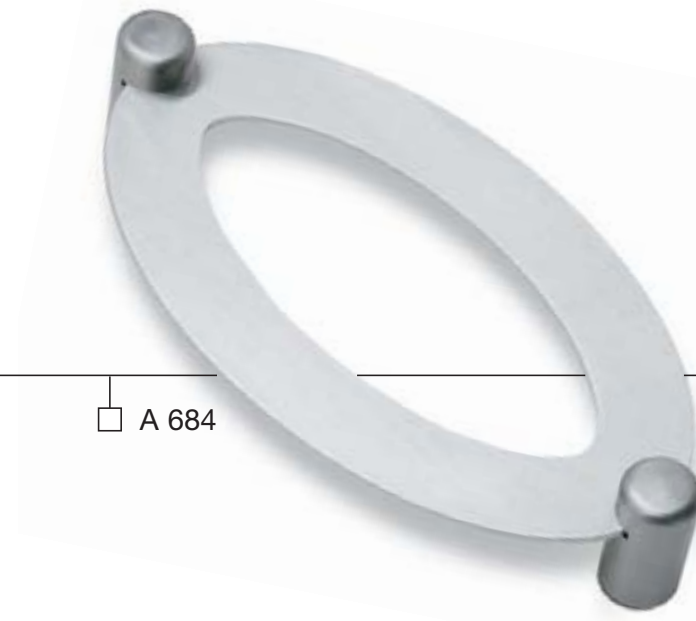

A 684

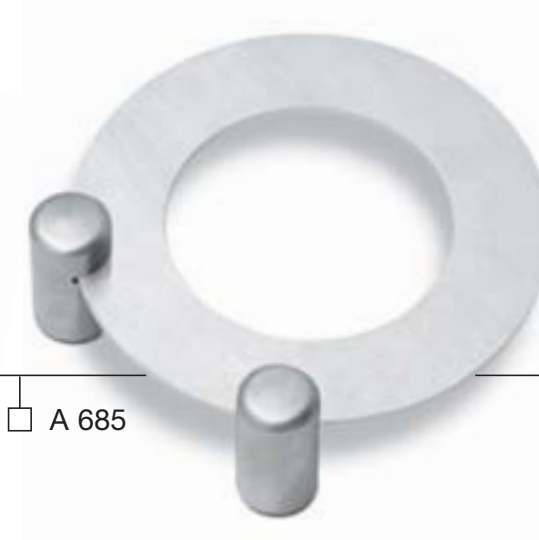

A 685

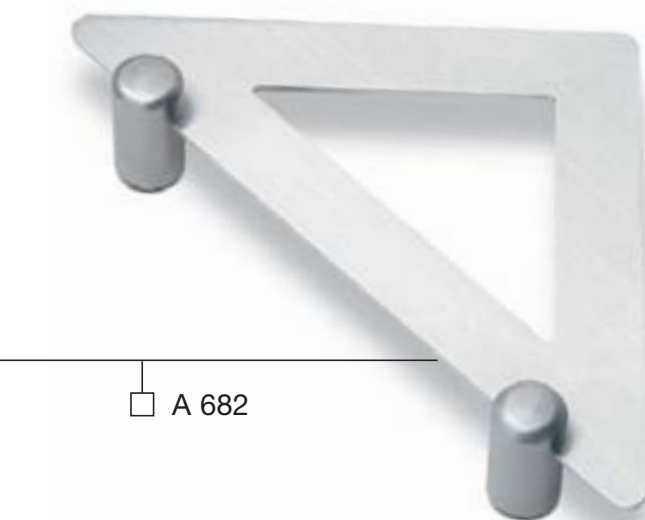

A 682

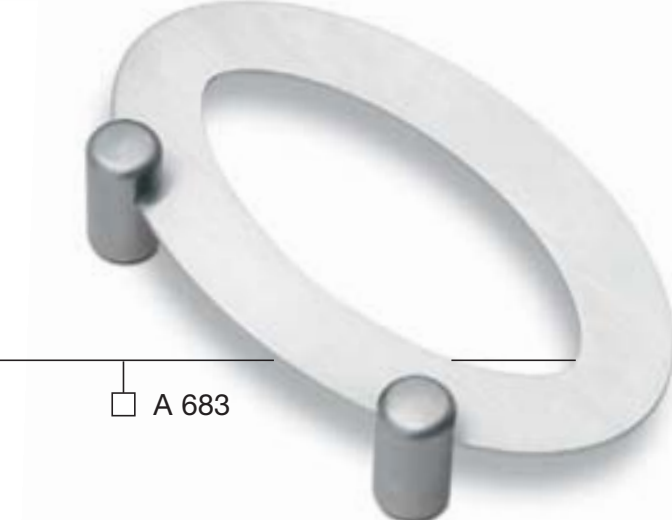

A 683

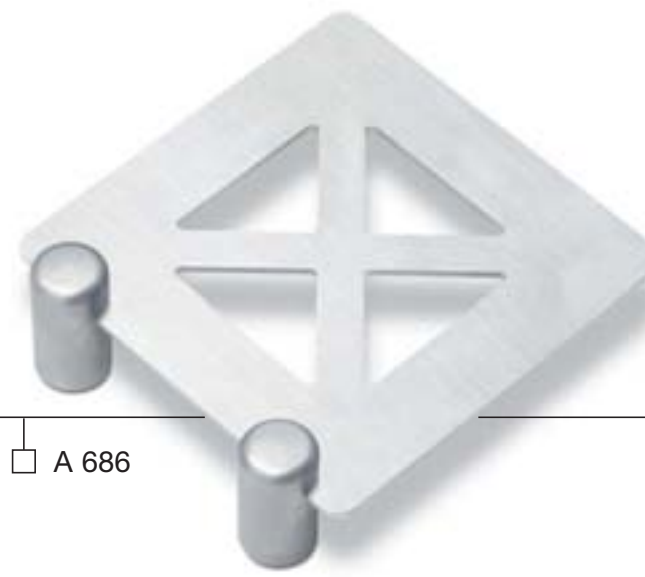

A 686



A 675

A 690

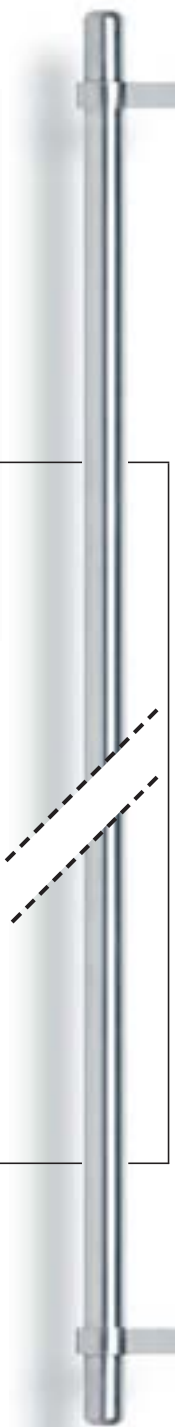

accessori

acciaio inox AISI 316

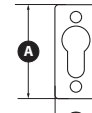
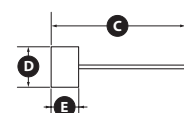
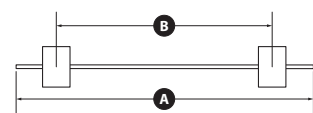

articolo	misure (mm)					attacco
	A	B	C	D	E	
A. 675	62	25
A. 680	420	250	157	65	34	P
A. 681	394	280	176	65	34	P
A. 682	372	250	212	65	34	P
A. 683	300	185	174	65	34	P
A. 684	334	300	174	65	34	P
A. 685	200	125	194	65	34	P
A. 686	200	125	217	65	34	P
A. 690	1700	1580	90	107	42	P

attacco passante · P



TORNA ALL'INDICE

INDIETRO



A 614

A 616

A 617

A 670

A 618

accessori

acciaio inox AISI 316

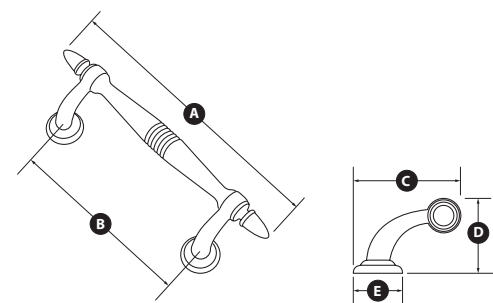

articolo	misure (mm)					attacco
	A	B	C	D	E	
A. 614	334	230	90	80	34	P
A. 616	306	230	90	80	34	P
A. 617	306	230	90	80	34	P
A. 618	387	230	126	84	34	P
A. 670	333	230	95	85	34	P

attacco passante · P



tecnica



- ▶ Grate Inox
- ▶ Vetri - Varianti vetro
- ▶ Montaggio e sostituzione vetri
- ▶ Misure vetri linea Classica
- ▶ Porte Blindate - Soluzioni personalizzate
- ▶ Porte in Alluminio - Porte in Alluminio Legno

- ▶ Porte in PVC Renolit - Porte Basculanti
- ▶ Finestre e Persiane - Pannelli Multiuso
- ▶ Pannelli con isolamento in Pirall
- ▶ Pannelli con supporto in MDF

Disegni Tecnici:

- ▶ Linea Style ▶ Linea Classica

grate inox AISI 316
inox grating AISI 316

Le grate in acciaio inox, oltre a rappresentare un oggetto decorativo che distingue e valorizza la vostra porta, sono studiate per proteggere il vetro da urti accidentali ed aumentare la sicurezza contro i tentativi d'intrusione.

The stainless steel grates, besides being decorative objects making your door more distinctive and beautiful, are designed to protect the glass from accidental blows and to increase security against attempts at entry.

TORNA ALL'INDICE

AVANTI



I vetri sono realizzati con sistema di vetro camera, di cui almeno un vetro esterno è sempre stratificato di sicurezza mentre quello interno è temprato e decorato. I vetri decorati sono realizzati interamente a mano sulla base del vetro GS.



All our glasses are produced with glass chamber system and, while outside there is a safety layered glass at least, inside the glass is tempered and decorated. The decorated glass are handmade on GS glass.

TORNA ALL'INDICE

AVANTI

INDIETRO



Vetro isolante e di sicurezza da mm. 16
(6/7 + 6 + 4)
per pannello mm. 18-19

*Insulating and security glass from mm. 16
(6/7 + 6 + 4)
panel mm. 18-19*



Vetro isolante e di sicurezza da mm. 19
(6/7 + 9 + 4)
per pannello mm. 24

*Insulating and security glass from mm. 19
(6/7 + 9 + 4)
panel mm. 24*



Vetro isolante e di sicurezza da mm. 25
(6/7 + 15 + 4)
per pannello mm. 27-30

*Insulating and security glass from mm. 25
(6/7 + 15 + 4)
panel mm. 27-30*



Vetro isolante e di sicurezza da mm. 34
(6/7 + 9 + 4 + 9 + 6/7)
per pannello mm. 38-39

*Insulating and security glass from mm. 34
(6/7 + 9 + 4 + 9 + 6/7)
panel mm. 38-39*



I decori sono realizzati a mano sul vetro GS.

The designs are handmade on type GS glass.



Vetro decorato AC
Designed glass AC



Vetro decorato GP
Designed glass GP



Vetro GS
Glass GS



Vetro decorato AN
Designed glass AN



Vetro decorato GN
Designed glass GN



Vetro satinato A
Satined glass A



Vetro satinato bronzo D
Satined glass bronze D





Un sistema rapido, semplice e sicuro, che facilita il montaggio e la sostituzione dei vetri sul pannello.

A fast, simple and safe system permits the fitting and replacement of glass onto the panel.

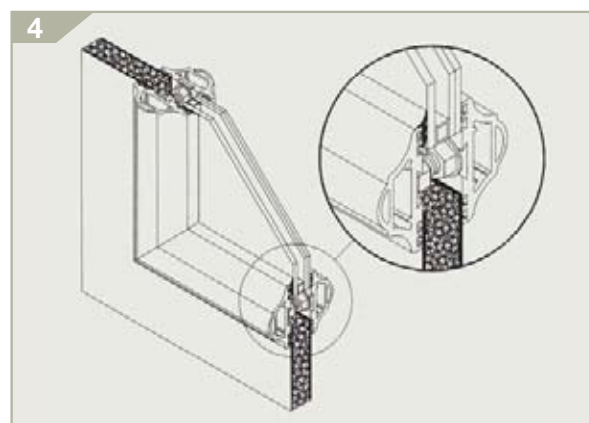
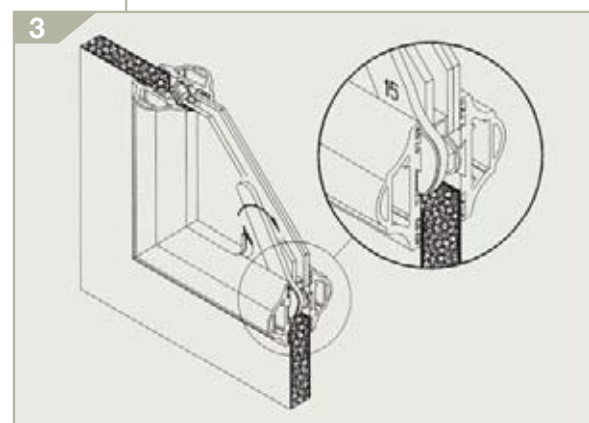
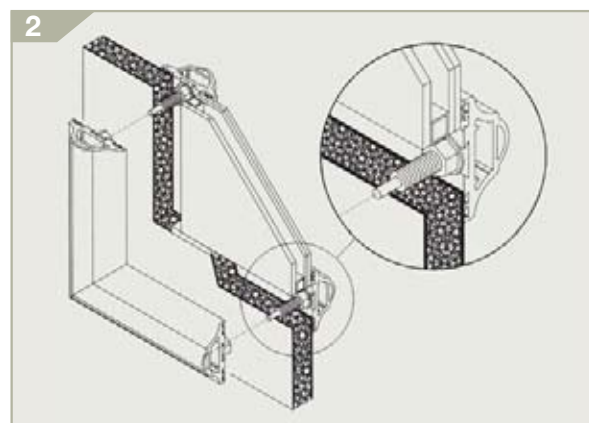
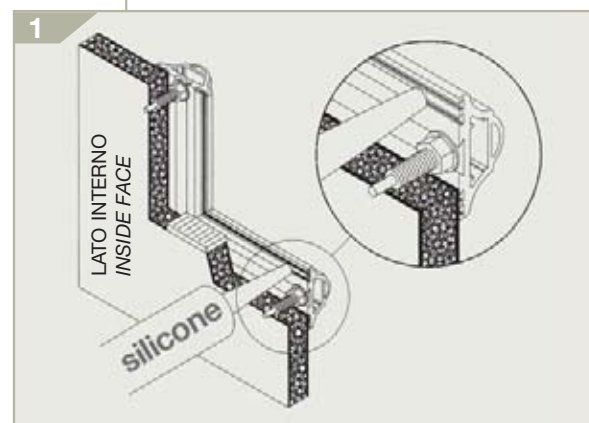
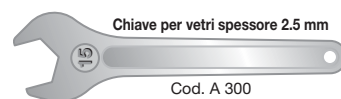

TORNA ALL'INDICE

AVANTI

INDIETRO

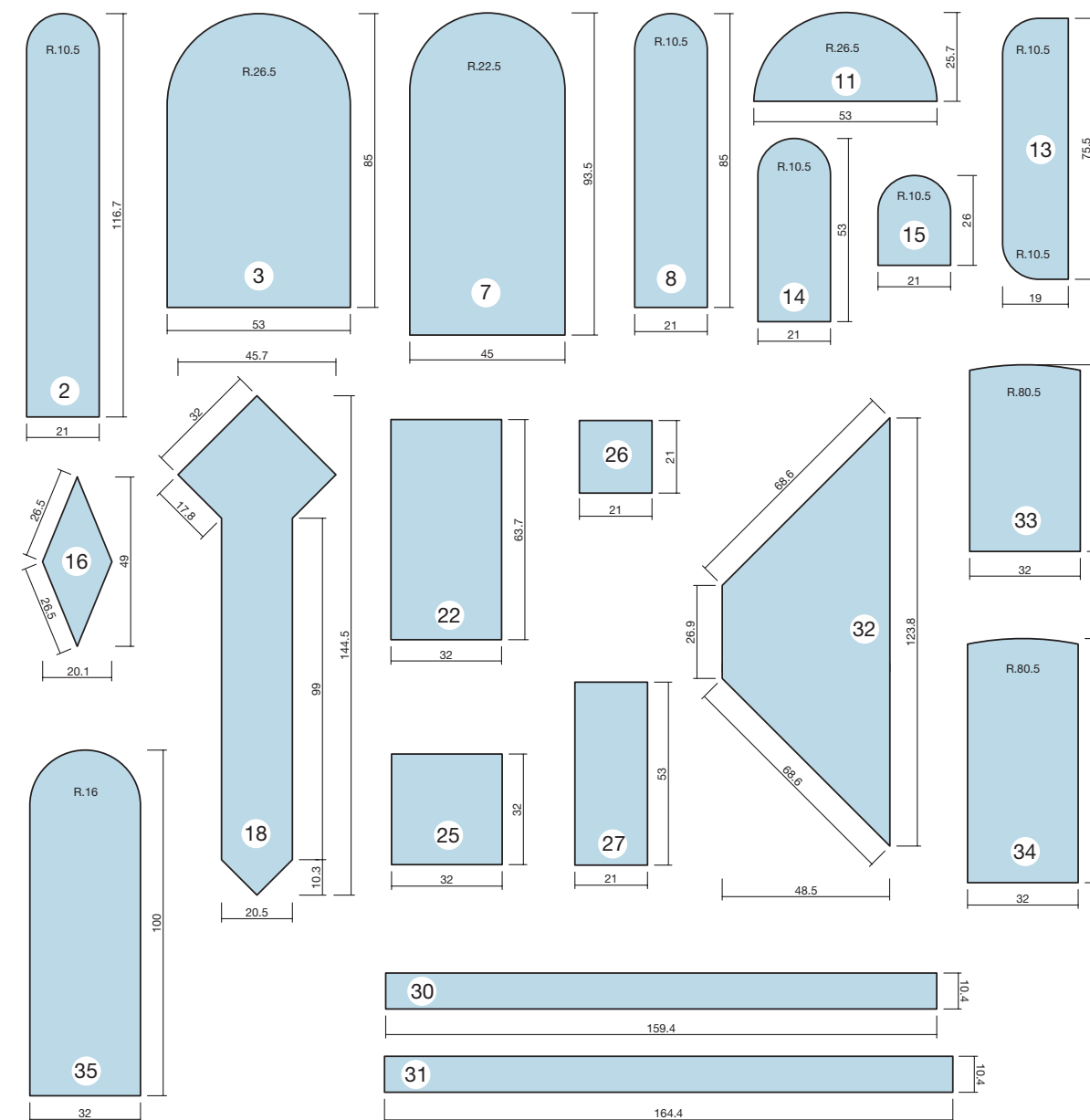

VETRO	MODELLO PORTA
2	Gemini, Rigel
3	Ikaro, Regolo, Sirio
7	Antares
8	Aldebaran,Alfair,Geo,Perseo,Regolo/KDS1-/KDM1
11	Bellatrix, Gemma, Libra, Minerva, Quasar
13	Pegaso, Quasar
14	Ikaro/KB1
15	Bellatrix, Minerva, Vega
16	Algenib, Basileo, Mizar, Nysa, Stilus/K1
18	Dorado/KB1

VETRO	MODELLO PORTA
22	Miranda, Victoria
25	Castore, Dorado, Iris, Miranda, Triade
26	Alfa, Eridano, Mira, Polaris, Titano
27	Bellatrix, Eridano, Mira, Polaris, Vega
30	Jolly/K1
31	Jolly/KG1
32	Sigma
33	Auriga/KB1
34	Ermes
35	Palladio

Nelle porte blindate, oltre al pannello, sono di fondamentale importanza anche gli accessori complementari di rifinitura: cornici per vetro, gocciolatoi, profili di battuta per le due ante, coprifili, rivestimenti per montanti e traversi, ecc. Il programma Aluform prevede tutte queste soluzioni realizzate su misura e dello stesso colore del pannello.

In the armoured doors, the complementary finishing accessories have a basic importance besides panels: frame for glass, drips, beating frames for both wings, wires cover for jamb and transoms, etc. The Aluform program provides for all these solutions made to measure and on the same colour of the panel.

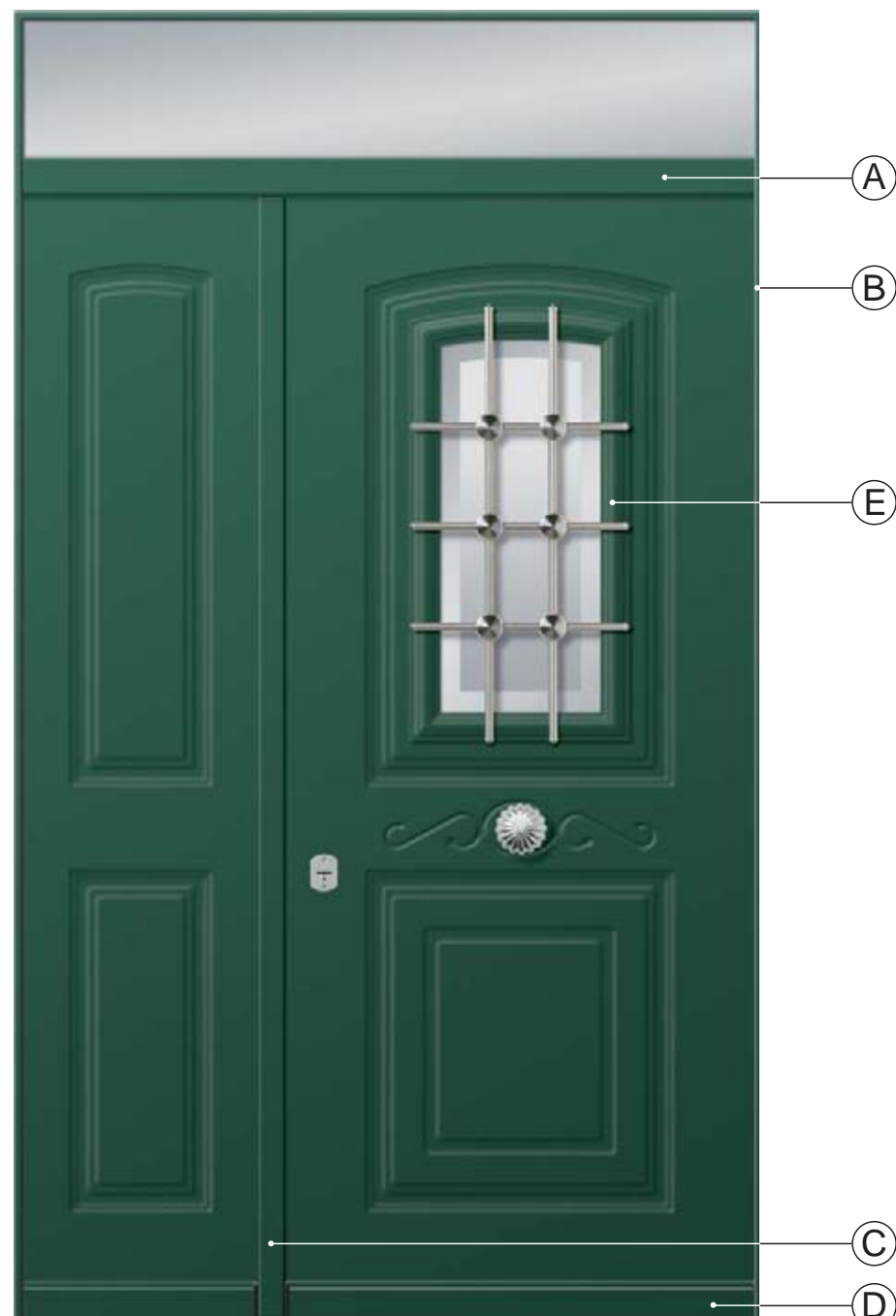

TORNA ALL'INDICE

AVANTI

INDIETRO

A
Profilo di rivestimento su misura per traversi e montanti
listino pag. 222

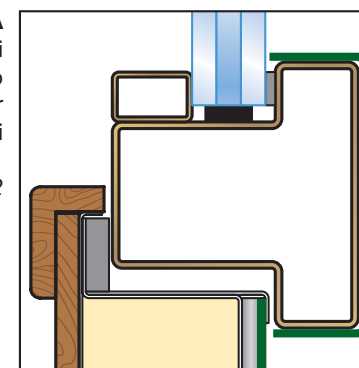

B
Profilo di rivestimento su misura per telai
listino pag. 222

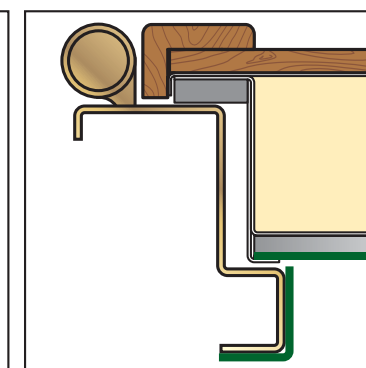

C
Profilo di rivestimento su misura per battuta porte a 2 ante
listino pag. 222

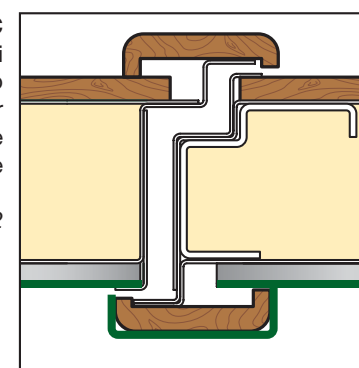

D
Gocciolatoio
listino pag. 222

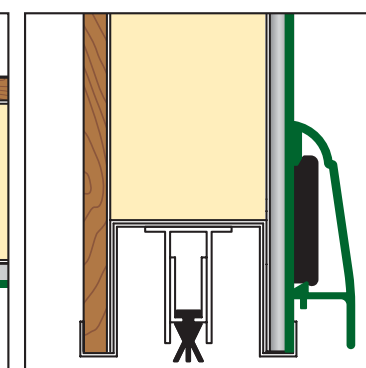

E/1
Cornice pannelli linea classica per vetro a filo esterno porta

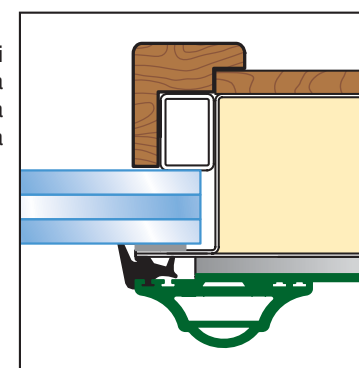

E/3
Cornice pannelli linea style per vetro a filo esterno porta

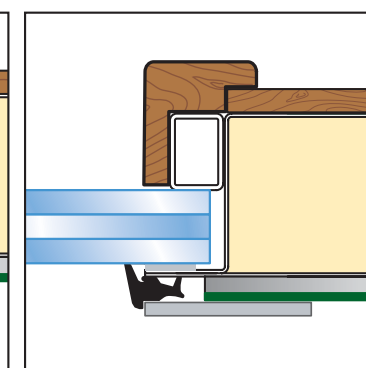

E/2
Cornice pannelli linea classica per vetro arretrato

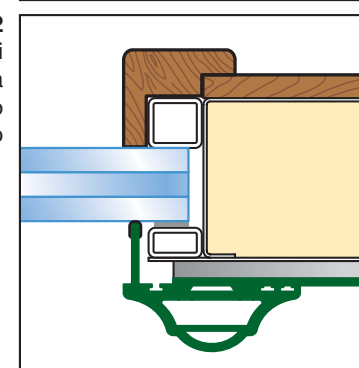

E/4
Cornice pannelli linea style per vetro arretrato

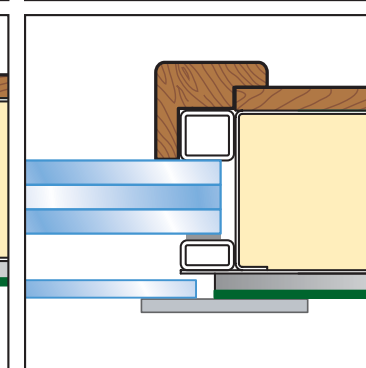

Per pannelli di spessore superiore a 7 mm. o soluzioni tipo E/2, indicare nell'ordine la misura di arretramento del vetro rispetto al filo esterno della porta.

Soluzione con supporto in MDF.

Solutions with support in MDF.

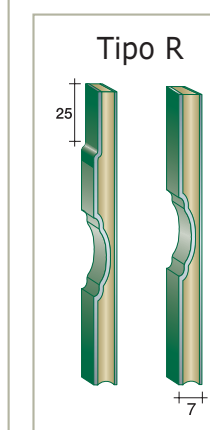

Soluzioni con isolamento in PIRALL.

Solutions with insulation in PIRALL.

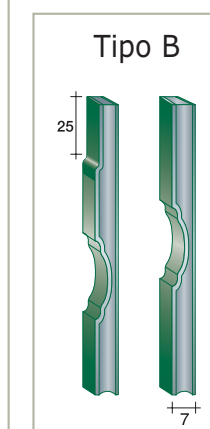

dimensioni e caratteristiche dei pannelli da pagina 193

Limitazioni di utilizzo dei pannelli su porte con telai a taglio termico.

La dilatazione termica derivante dall'irraggiamento solare della faccia esterna della porta, può causare una flessione verticale della porta (pannello e telaio) nel lato di apertura, quindi il conseguente bloccaggio temporaneo dei rostri della serratura. Per limitare questo fenomeno,

consigliamo di utilizzare pannelli nella tipologia a giunto elastico, non superare una altezza anta di 215 cm compreso il telaio mobile e preferire possibilmente l'installazione di serrature con rostri ad avanzamento frontale e cilindro a sforzo rapportato. Non sono da evidenziare particolari disposizioni sulle porte realizzate nel colore bianco o con telai "freddi" (non a taglio termico).

Restrictions of utilization of panels for front doors with thermic-cutting frames.

Thermic dilatation for sun irradiation on the outside of the doors, can be the cause of the vertical flexion of the door (panel and frame) in the opening side, so the consequent temporary jamming of the lock-bills. To limit this symptom, we suggest using our panels with elastic joint, not exceeding cm.215 for the wing-height included movable frame and preferring installation of locks with front-advancement bills and cylinder with refereed effort. Any particular advices aren't necessary for doors white painted or built with "cold" frame (instead of thermic-cutting).



dimensioni e caratteristiche dei pannelli da pagina 193

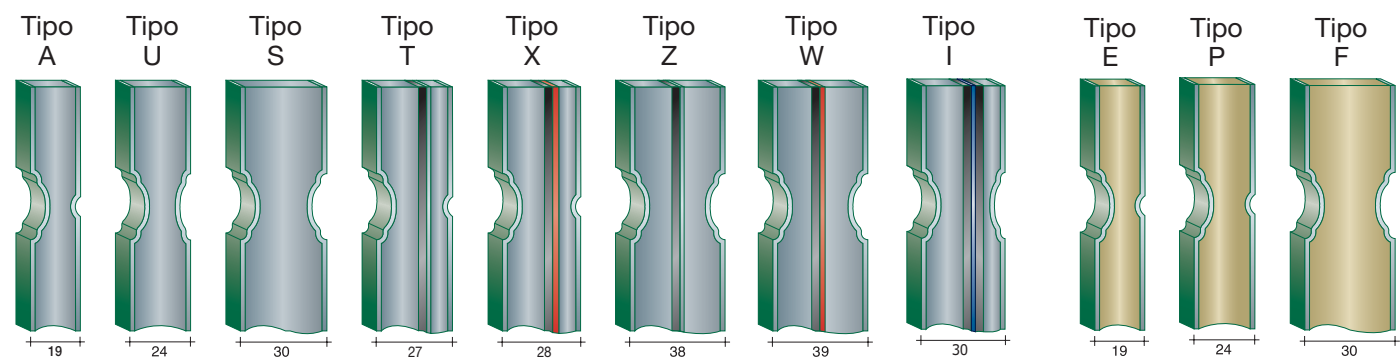

Soluzioni con isolamento in PIRALL.

Solutions with insulation in PIRALL.

Soluzioni con supporto in MDF.

Solutions with support in MDF.

I pannelli Aluform monofaccia nella sezione Tipo K e Tipo Q sono studiati per la realizzazione di porte in alluminio esterno e legno interno. I due pannelli di materiali diversi, possono avere comportamenti differenti fra loro, consigliamo pertanto di non incollare il pannello in alluminio con quello in legno.

Our mono-side Aluform panels in the type K and type Q section are planed for the realization of doors aluminium-outside and wood-inside. As since both panels are in two different material, can have different behaviour and so we suggest not sticking aluminium panels with wood one.



dimensioni e caratteristiche dei pannelli da pagina 193

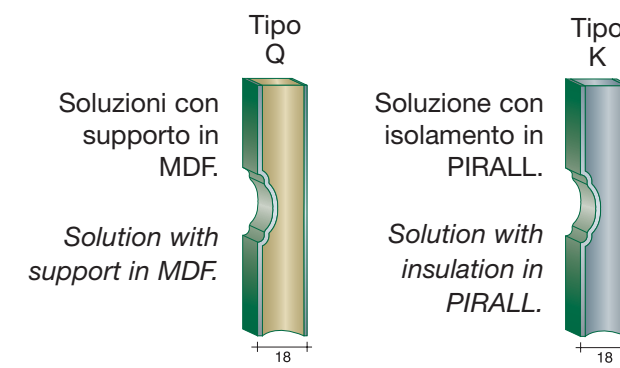

I pannelli Aluform nella sezione Tipo U e Tipo P hanno un nucleo centrale di isolamento rispettivamente in Pirall o MDF, assemblato a lastre di alluminio rivestite con pellicole Renolit effetto legno. Aluform ha scelto il sistema di applicazione delle pellicole Renolit con procedimento a freddo. L'applicazione a freddo infatti è reputato il miglior sistema di incollaggio delle pellicole Renolit, in quanto non altera le caratteristiche di resistenza agli agenti atmosferici, che hanno reso famose queste pellicole.

Our Aluform panels in Type U and Type P section have a central part of isolation respectively in Pirall or MDF, put together aluminium sheets covered by Renolit wood-effect film. Aluform has chosen the cold procedure for the Renolit film application. Infact, the cold application is considered the best sticking system for Renolit film, as it doesn't change the resistance characteristics to the atmospheric agents, that made famous these films.

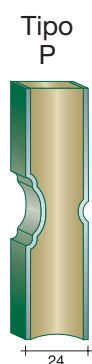

Tipo P
Soluzione con supporto in MDF.
Solution with support in MDF.



Tipo U
Soluzione con isolamento in PIRALL.
Solution with insulation in PIRALL.

dimensioni e caratteristiche dei pannelli da pagina 193

Le porte basculanti, in abbinamento coordinato alle porte d'ingresso, sono un'altra interessante proposta per l'applicazione dei pannelli Aluform. Per installare i pannelli Aluform, la porta basculante deve avere il telaio perimetrale che possa contenere i pannelli ed i montanti verticali per la giunzione modulare fra gli stessi. Il pannello Tipo A pesa circa 9 kg al metro quadro e può essere richiesto nelle misure massime di 1100 X 2500.

The pivoted doors, coupled to the front doors, are an other interesting propose for the utilization of Aluform panels. For putting on our Aluform panels, the pivoted doors must have a perimetrical frame able to keep the panels and the vertical jambs for their modular joining. The weight of the Type A panel is about kg.9 for square metre and can be required in the maxim dimension mm.1100x2500.

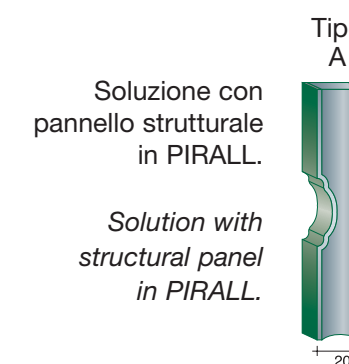

Tipo A
Soluzione con pannello strutturale in PIRALL.
Solution with structural panel in PIRALL.



dimensioni e caratteristiche dei pannelli da pagina 193

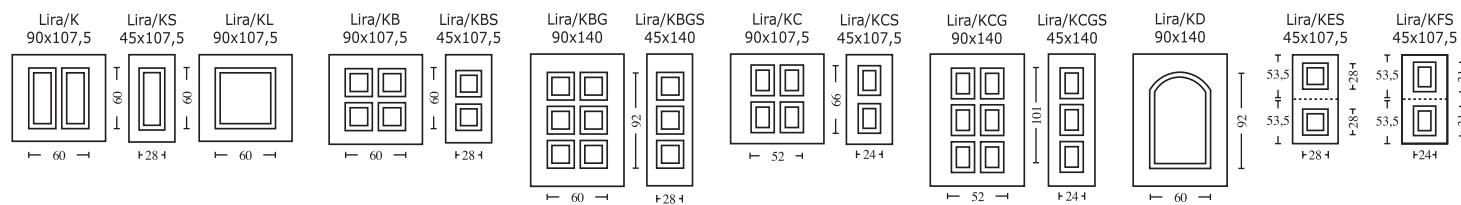
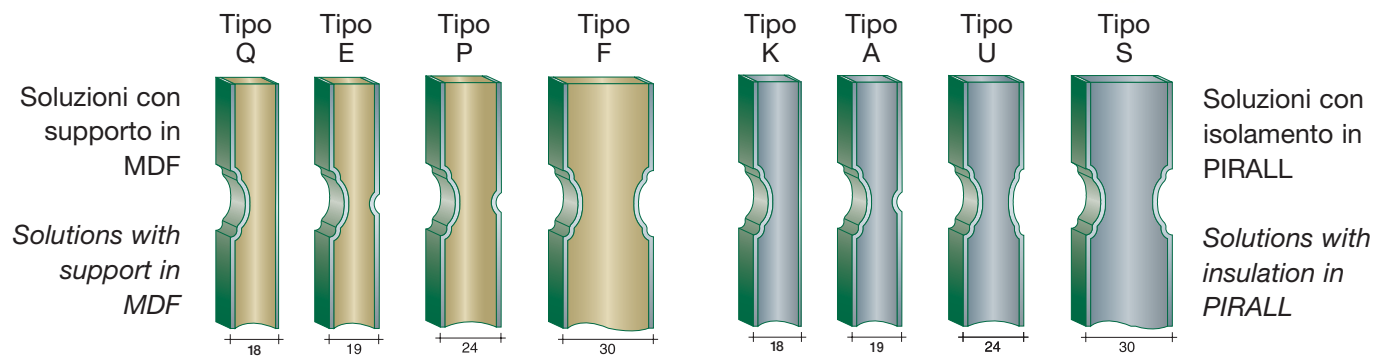

Il design delle bugne non è abbinabile alle altre linee di pannelli.

pannelli multiuso
multipurpose panels

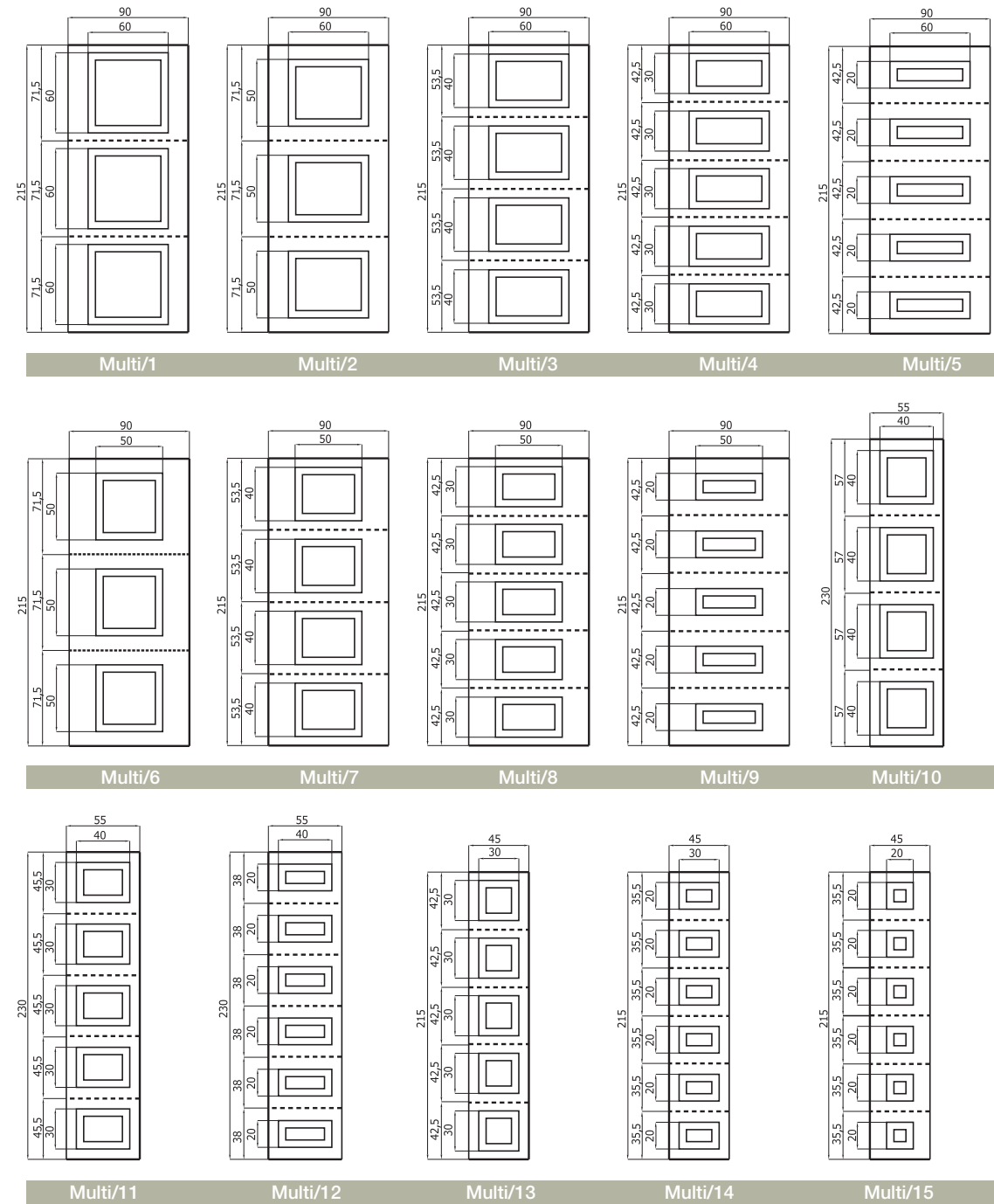

- I pannelli multiuso vengono forniti nel formato intero come da disegno.
- Nei colori legno e Renolit, le venature sono nel senso verticale del pannello.
- Disponibili solo nella sezione L e J.

- The multiuse panels are supplied in the full form as in the design.
- In the colors wood and Renolit, the wood veins are arranged vertically in the panel.
- Only available in L and J section.

Tipo J



Tipo L



- A** Lastra in alluminio bugnato prof. mm 10
Embossed aluminium sheathing mm 10
- B** Isolamento in PIRALL
PIRALL insulation
- F** Supporto in M.D.F.
M.D.F. support

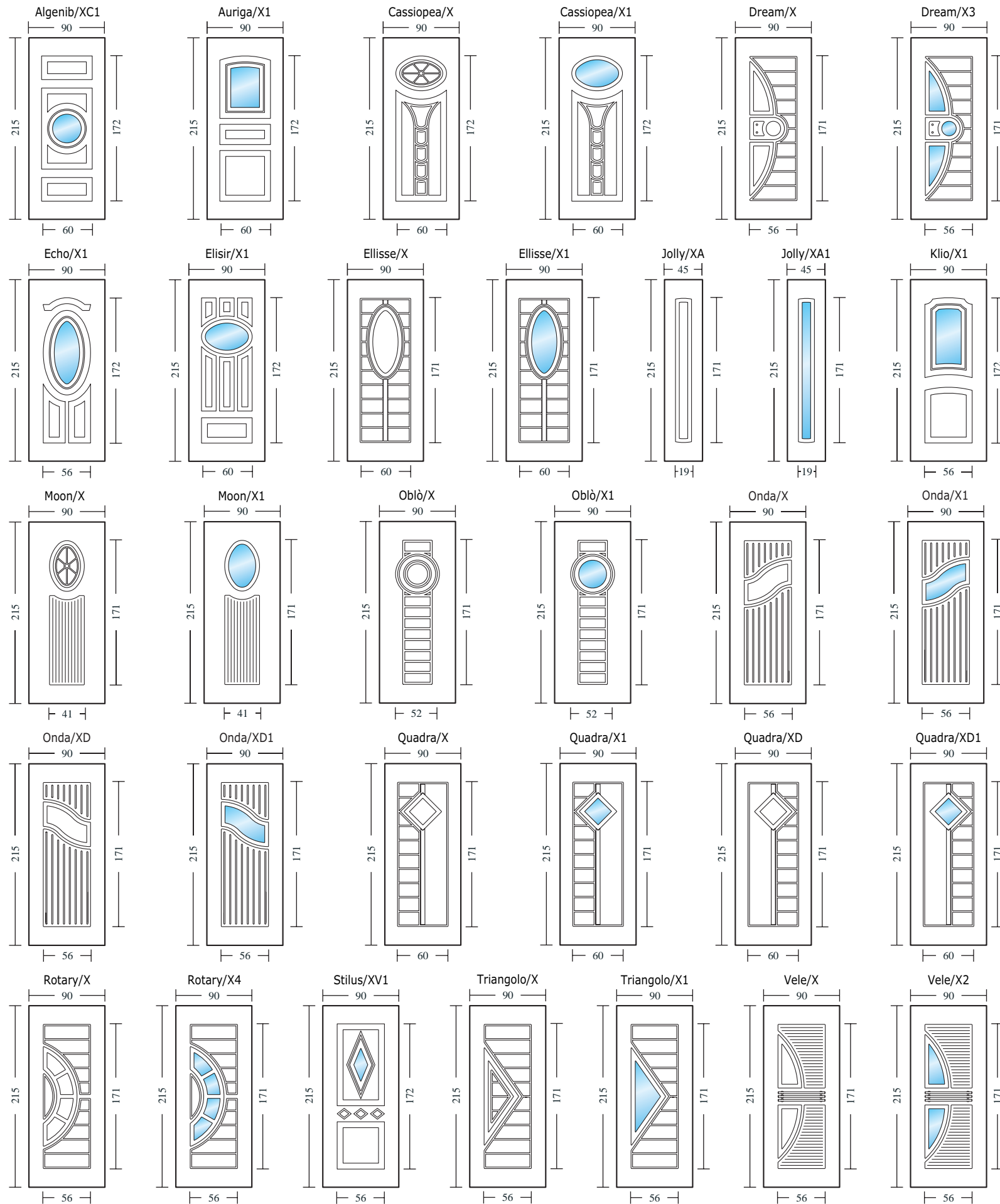

MISURE PANNELLI Standard: Tipo B anta grande 110x230 anta piccola 55x230
 Tipo U,T,X,I,S: anta grande 90x215 anta piccola 45x215
 Maggiorate: Tipo U,T,X,I,S: anta grande 110x230 anta piccola 55x230

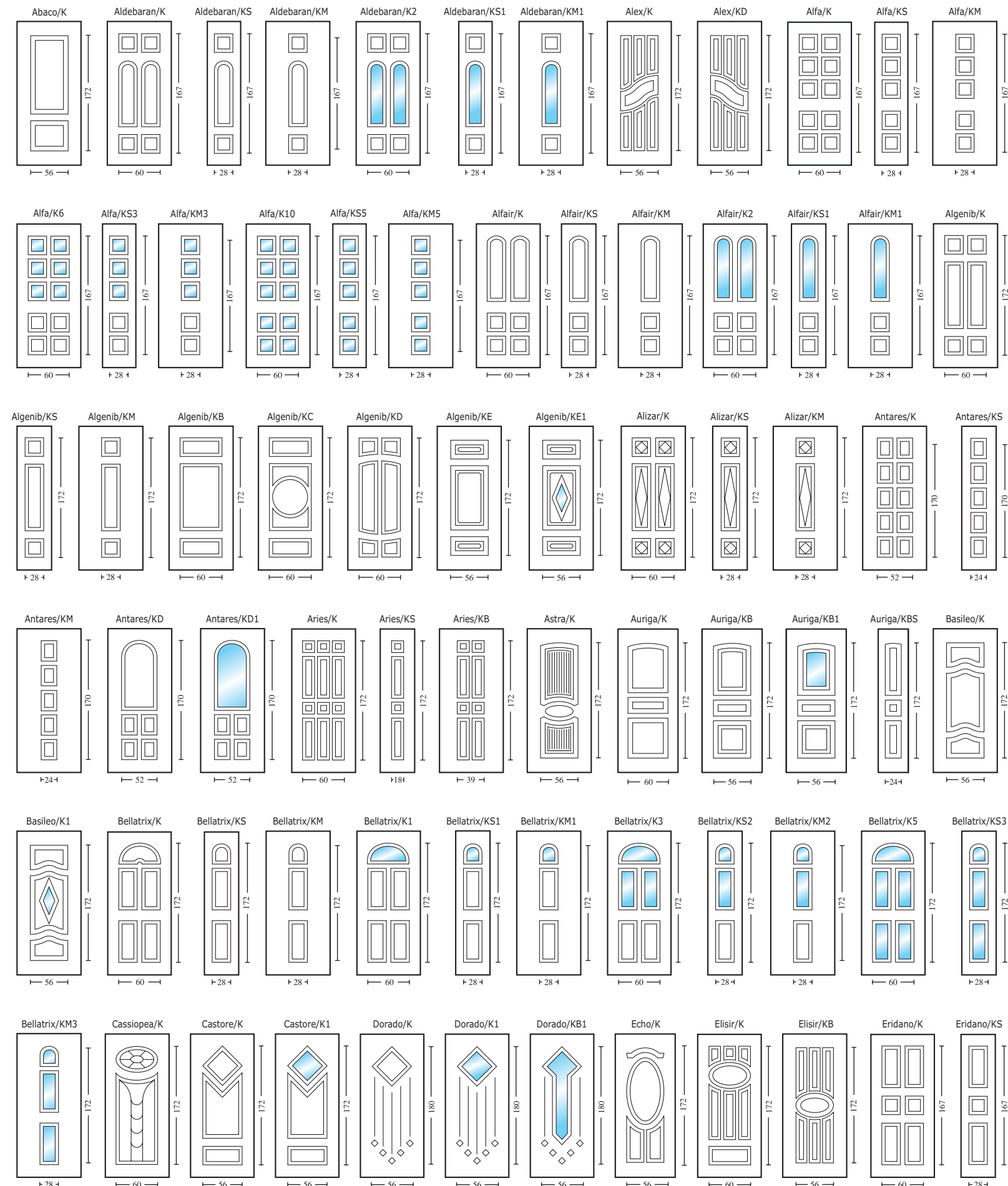

MISURE PANNELLI Standard: Tipo B e Tipo R anta grande 110x230 anta piccola 55x230
 Tutte le altre sezioni: anta grande 90x215 anta piccola 45x215

Maggiorate: Tipo R anta grande 110x250 anta piccola 55x250
 Tutte le altre sezioni: anta grande 110x230 anta piccola 55x230
 Misure ridotte: Tipo R anta grande 95x215

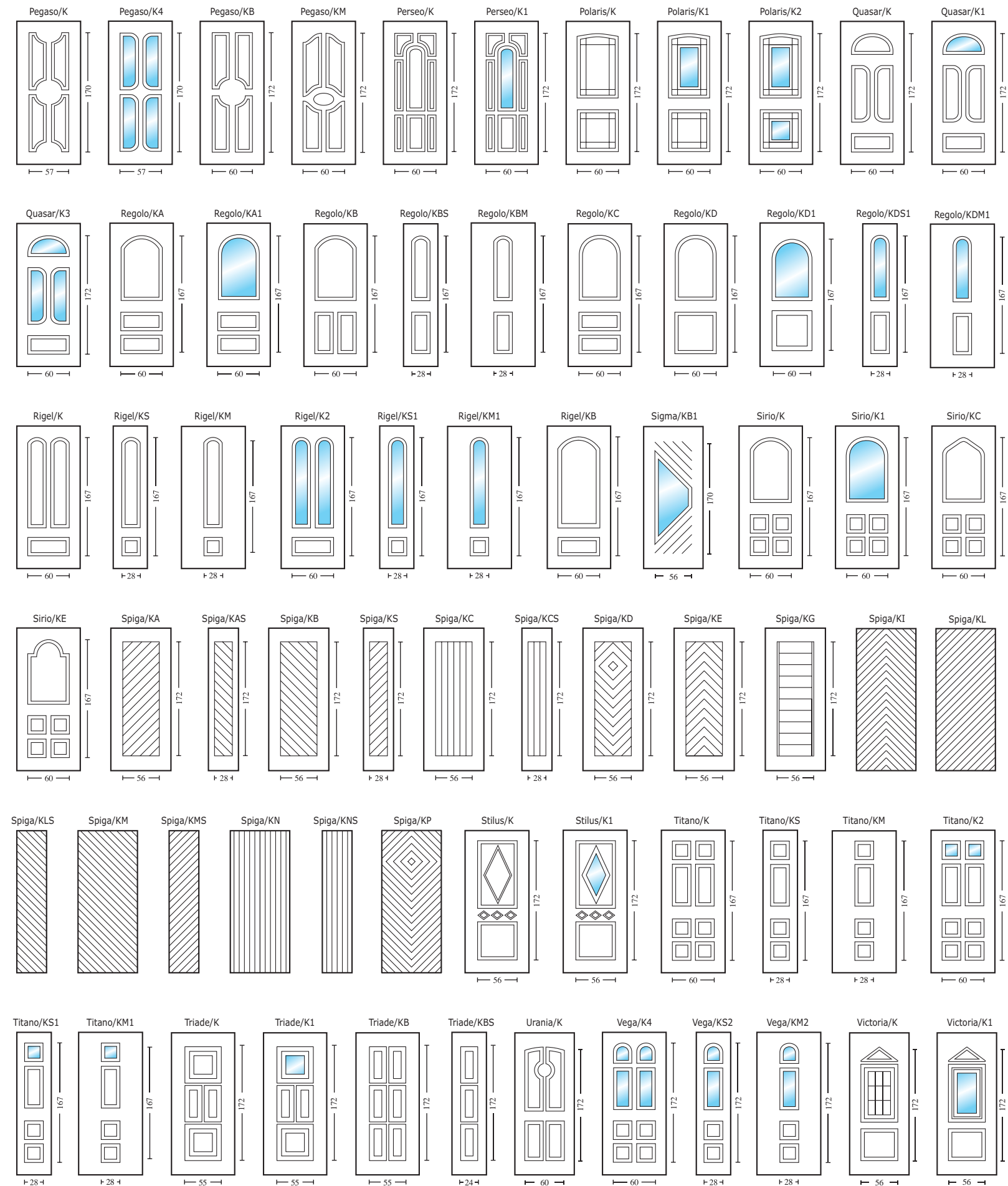
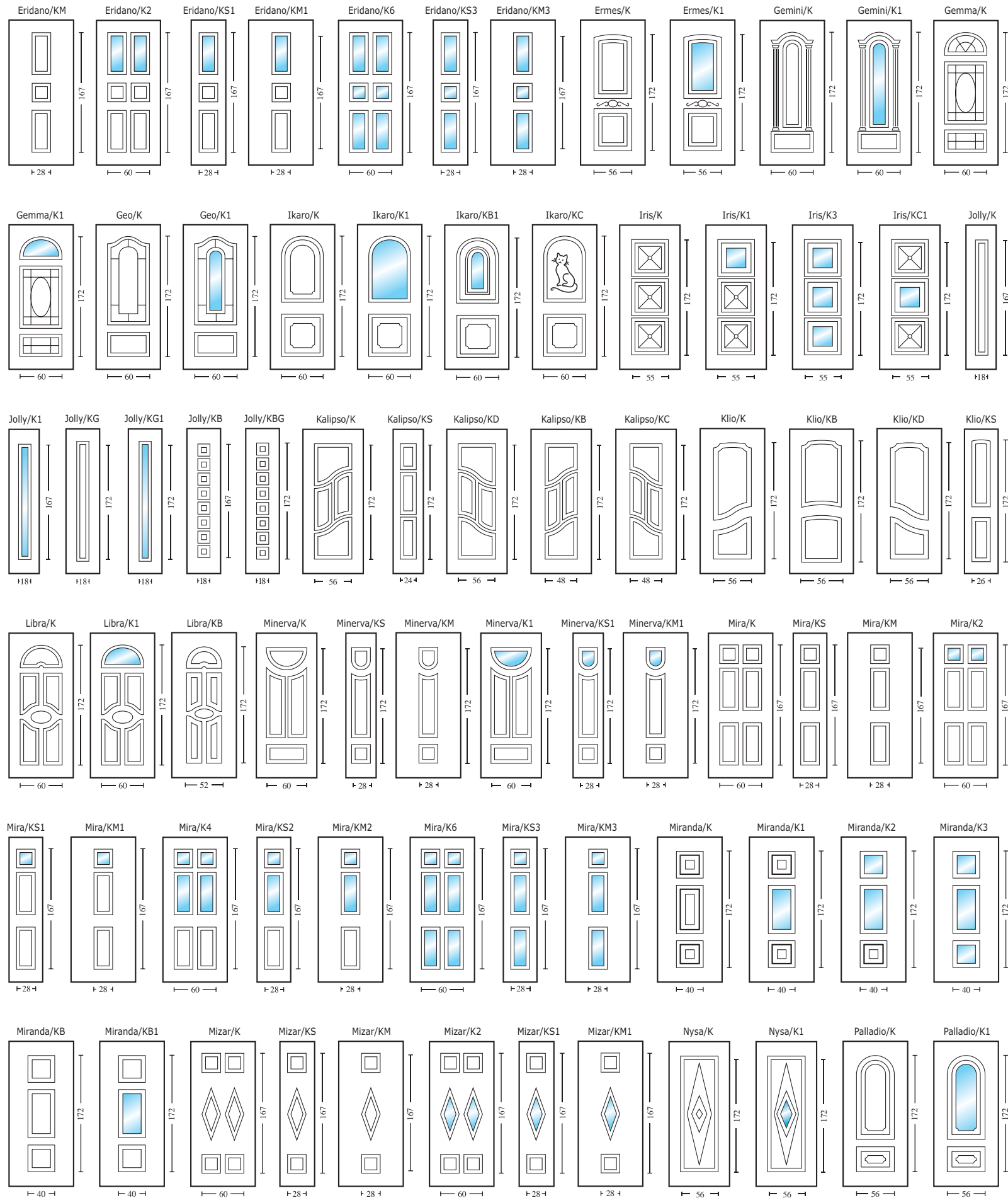

MISURE PANNELLI
 Standard: Tipo B e Tipo R anta grande 110x230 anta piccola 55x230
 Tutte le altre sezioni: anta grande 90x215 anta piccola 45x215

Maggiorate: Tipo R anta grande 110x250 anta piccola 55x250
 Tutte le altre sezioni: anta grande 110x230 anta piccola 55x230
 Misure ridotte: Tipo R anta grande 95x215

MISURE PANNELLI
 Standard: Tipo B e Tipo R anta grande 110x230 anta piccola 55x230
 Tutte le altre sezioni: anta grande 90x215 anta piccola 45x215

Maggiorate: Tipo R anta grande 110x250 anta piccola 55x250
 Tutte le altre sezioni: anta grande 110x230 anta piccola 55x230
 Misure ridotte: Tipo R anta grande 95x215

Il PIRALL è un materiale affidabile, leggero e con caratteristiche di isolamento termico incomparabili. Queste eccellenti proprietà sono ottenute da una particolare formulazione di schiume rigide con speciali additivi che conferiscono al prodotto eccezionali caratteristiche meccaniche; inoltre, è esente da C.F.C. e vanta una reazione al fuoco di classe B2.

Il PIRALL è stato studiato dalla ROYAL PAT in collaborazione con aziende chimiche all'avanguardia e nel pieno rispetto delle più rigorose leggi in materia ambientale.

PIRALL is a light and reliable material with incomparable thermic insulation specifications. These properties were obtained from a unique formulation of rigid foams with special additives which give the product exceptional mechanical characteristics; it is also CFC-free and has a fire rating of Class B2.

PIRALL was developed by ROYAL PAT in collaboration with leading chemical companies in full compliance with the most rigorous laws on the environment.

Altre caratteristiche del PIRALL®:

- Resistenza alla compressione (ISO 844) kPa 2600 ± 200;
- Conduttività termica a 10 C (ISO 8301) mW/m K 31;
- Assorbimento d'acqua (ISO 2896) %3;
- Stabilità dimensionale spessore 48h a 100 (ISO 2796) 1,0;
- Temperatura massima d'esercizio C + 120 -180;
- Reazione al fuoco (DIN 4102) classe B2 (ISO 3582) mm <30.

Other features of PIRALL®:

- Resistance to compression (ISO 844) kPa 2600 ± 200;
- Thermal conductivity at 10 C (ISO 8301) mW/m K 31;
- Absorption of water (ISO 2896) %3;
- Dimensional stability of thickness 48h at 100 (ISO 2796) 1.0;
- Maximum operating temperature C + 120 -180;
- Fire rating (DIN 4102) class B2 (ISO 3582) mm <30.

GARANZIA 10 ANNI
GUARANTEE YEARS

I pannelli con isolamento in PIRALL sono garantiti 10 anni da rigonfiamenti o alterazioni dovute ad eventuali infiltrazioni d'acqua.

The panels with insulation in PIRALL are guaranteed for 10 years from swelling or alterations due to the infiltration of water.



NEW GENERATION

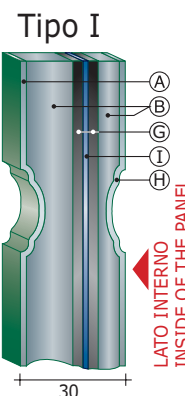

PANNELLO FONOISOLANTE

Aluform è attenta alle crescenti esigenze per la sicurezza passiva e la salvaguardia della salute. Per questo motivo abbiamo aggiunto alla nostra ampia gamma di prodotti il pannello Tipo I. I come isolamento totale con soluzioni di isolamento termico ma anche e soprattutto di isolamento acustico. Un prodotto in grado di rivoluzionare con la massima semplicità il modo di interpretare la casa, protetti dagli sbalzi di temperatura e liberi dall'inquinamento acustico. Una risposta concreta alle nuove esigenze del cliente, sempre più sensibile a questo tipo di valori.

PHONO INSULATING PANEL

Aluform pays attention to the increasing needs for passive safety and health safeguard. For this reason we have added to our wide range of products the panel type I section. I means total isolation with thermic insulation solutions but also and moreover acoustic insulation. A new product able to revolutionize own way of meaning the home with simplicity, protected from sudden change and acoustic contamination free. A concrete answer for the new customer needs, always more sensitive to these kind of values.

Misure standard:
90x215 e 45x215
Misure maggiorate:
110x230 e 55x230

Standard dimension:
90x215 and 45x215
Oversize dimension:
110x230 and 55x230

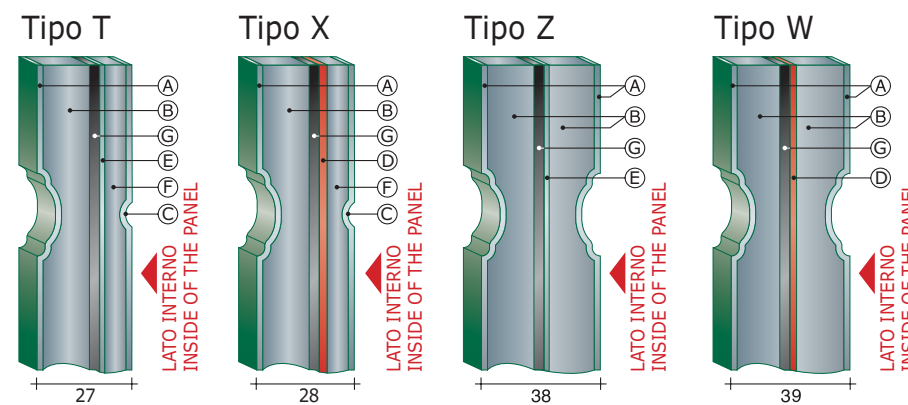
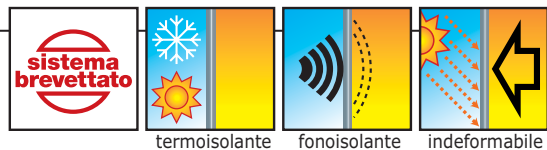

PANNELLI A GIUNTO ELASTICO

I pannelli in PIRALL a giunto elastico sono studiati per limitare il fenomeno della dilatazione termica derivante dall'irraggiamento solare.
Misure standard: 90x215 e 45x215
Misure maggiorate: 110x230 e 55x230

PANELS WITH ELASTIC JOINT.

Our panels in Pirall with elastic joint are developed to limit the thermic dilatation symptom for sun irradiation. Standard dimension: 90x215 and 45x215 Oversize: 110x230 and 55x230

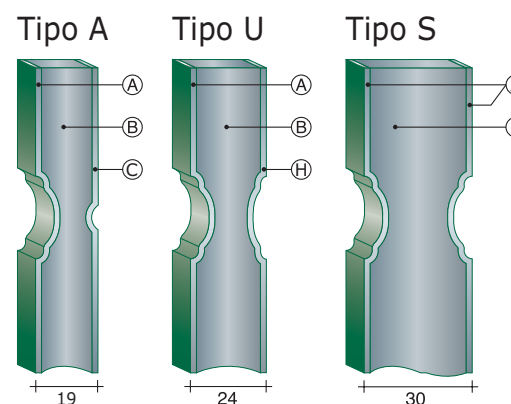

PANNELLI BASE (1)
Misure standard: 90x215 e 45x215
Misure maggiorate: 110x230 e 55x230
Misure extra solo tipo A: 110x250

BASIC PANELS (1)
Standard dimension: 90x215 and 45x215
Oversize dimension: 110x230 and 55x230
Oversize by request only for type A: 110x250

(1) Vedere limitazioni di utilizzo a pag. 182

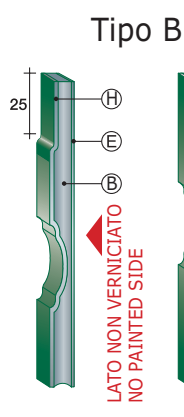

PANNELLI MONOFACCIA PER PORTE BLINDATE

Misure standard: 110x230 e 55x230
Spessore standard **7 mm.**
Spessori maggiorati: 9,5, 12 mm
Spessori ridotti: 4, 5, 6 mm con bordi ribassati solo su pannelli a misura

MONO-SIDE PANELS FOR ARMoured DOORS

Standard dimension: 110x230 and 55x230
Standard Thickness: **7 mm**
Oversize thickness: 9.5, 12 mm
Reduced thickness: 4, 5, 6 mm with reduced edge only on panels to measure.

TABELLA PESI (il peso indicativo si riferisce ai pannelli ciechi)

Tipo	A	B	I	K	S	T	U	W	X	Z
	Pirall	Pirall	Pirall	Pirall	Pirall	Pirall	Pirall	Pirall	Pirall	Pirall
Peso mq	9.0	6.5	21.0	7.0	11.5	15.0	10.0	24.5	25.0	15.5

Tipo K

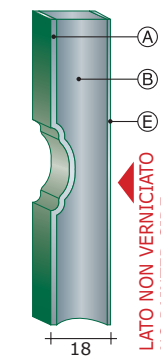

PANNELLI MONOFACCIA PER PORTE IN ALLUMINIO/LEGNO
Misure standard: 90x215 e 45x215
Misure maggiorate: 110x230 e 55x230

MONO-SIDE PANELS FOR ALUMINIUM/WOOD DOORS
Standard dimension: 90x215 and 45x215
Oversize dimension: 110x230 and 55x230

- (A) Lastra in alluminio bugnato prof. mm 13
Embossed aluminium sheeting mm 13
- (B) Isolamento in PIRALL®
PIRALL® insulation
- (C) Lastra in alluminio dogato
Grooved aluminium sheeting
- (D) Lastra in acciaio zincato
Zinc-treated sheeting
- (E) Lastra in alluminio non verniciato
No painted aluminium sheeting
- (F) Isolamento in M.D.F.
M.D.F. insulation
- (G) Giunto elastico
Elastic joint
- (H) Lastra in alluminio bugnato prof. mm 5
Embossed aluminium sheeting mm 5
- (I) Barriera fonoisolante
Phono insulating barrier

Aluform pannelli con supporto in MDF
panels with MDF support

L'MDF è un materiale composto principalmente da fibre di legno "legate" fra loro con particolari resine. Per la semplicità nelle lavorazioni, reperibilità e costo contenuto, l'MDF è il materiale più utilizzato nella costruzione di pannelli bugnati in alluminio. Occorre però precisare che l'MDF, anche se molto diffuso nella costruzione di prodotti per l'arredamento, non è un materiale con specifiche qualità di isolamento termico né possiede caratteristiche di idrorepellenza tali da garantire assenza di rigonfiamento in caso di assorbimento di umidità. Pertanto, non possiamo offrire particolari garanzie di inalterabilità nel tempo sui prodotti realizzati con supporto in MDF.

The MDF is made up wood-fibre put on together by specific resin. For the easy manufacture, available and low cost, the MDF is the most used product in aluminium embossed panels construction. Anyway, it's necessary to specify that the MDF, although its wide-spread in furnishing products, has neither specific thermic isolation quality nor waterproof characteristics such as to guarantee blowing up free in humidity absorption cases. So, we cannot offer particular unchanging warranty in the long run on our products made with MDF support

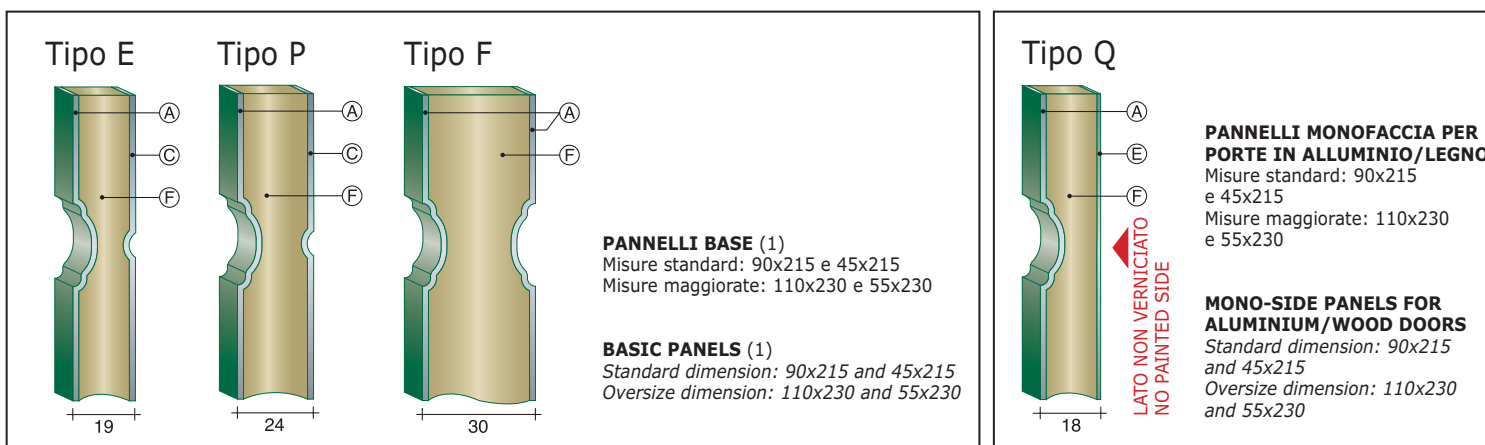

(1) Vedere limitazioni di utilizzo a pag. 182

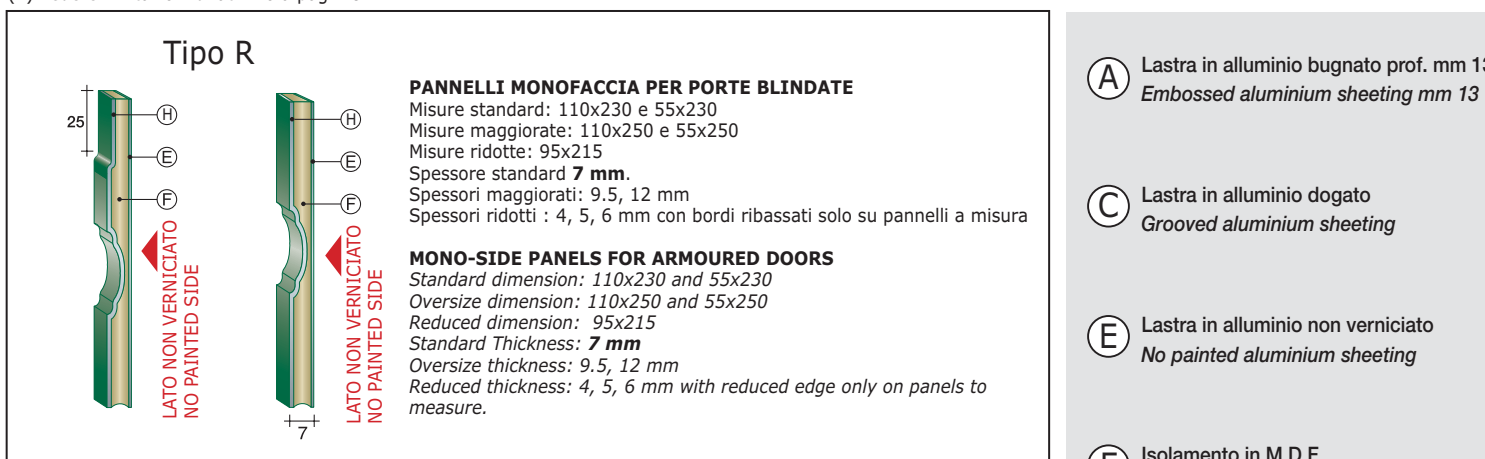

TABELLA PESI (il peso indicativo si riferisce ai pannelli ciechi)

Tipo	E MDF	F MDF	M MDF	P MDF	Q MDF	R MDF
Peso mq	16.0	20.5	15.0	19.0	14.0	8.5

- A** Lastra in alluminio bugnato prof. mm 13
Embossed aluminium sheeting mm 13
- C** Lastra in alluminio dogato
Grooved aluminium sheeting
- E** Lastra in alluminio non verniciato
No painted aluminium sheeting
- F** Isolamento in M.D.F.
M.D.F. insulation
- H** Lastra in alluminio bugnato prof. mm 5
Embossed aluminium sheeting mm 5